



FRONTIER20

 **LANDMARK**
CERAMICS

A new landmark in the porcelain industry

Landmark Ceramics is an American company, based in Tennessee that has set out to research, manufacture and sell top quality porcelain ceramics in North America. Technological innovation, market presence, attention to detail, the welfare of people and the environment, efficient service and a thorough product range make Landmark a new benchmark in the North American market for those who are looking for a reliable partner for any building and architecture project using US made top quality porcelain material.

FRONTIER²⁰

Frontier20 is a porcelain pavers collection perfectly suited for outdoor applications. The market's demand for a stain-proof, slip-resistant, chemical resistant, no maintenance product led to the development of a revolutionary aesthetically superior product, enough versatility for exteriors as well as interiors. Combining the highest level of quality control and technology with state-of-the-art equipment, age-old practices have been revitalized to offer a superior industry leading product. Frontier20 offers a dimension never seen before to your outdoor living area.

OVERVIEW	2
DESTINATIONS OF USE	6
CONTINUITY IN & OUT	10
COMPLETE LAYING VERSATILITY	14
01. DRY LAYING	18
02. OVER REINFORCED CONCRETE	26
03. OVER DECKING	28
04. RAISED FLOORS	30
TRIM TILES TO LANDSCAPE THE OUTDOORS	36
TRIM TILES RANGE	44

LEARN MORE ABOUT



A COMPLETE PROJECT FOR EVERY NEED	48
01. WIDE LOOKS RANGE	50
02. A WIDE RANGE OF DIFFERENT SIZES	56
03. AMERICAN STONE	58
04.1 BLUESTONE DESIGN PROJECT	62
04.2 QUARTZITE DESIGN PROJECT	72
04.3 TRAVERTINE CROSS CUT DESIGN PROJECT	82
04.4. INDIANA SALEM DESIGN PROJECT	88
05. DESIGN WORK PROJECT	96
06. FRONTIER20 - DECO	108
MULTI PATTERN DESIGN - M.P.D.	114
PRODUCT RANGE	144
TECHNICAL INFORMATION	182

PERFORMANCE, FUNCTIONALITY AND AESTHETICS: ALL IN 20MM.

Frontier20 porcelain pavers are inherently slip resistant and impervious to chemicals, salt, fading, or scratching.

Free your self from having to commit to yearly sealing practices.

Your Frontier20 will never fade or need sealing!

Simply pressure wash your way to a newly installed look any time you want. Moss and mold also won't be an issue, they too can easily be cleaned off without fear of streaking. The ultra realistic surface of Frontier20 is physically bound and can not fade or be removed.

Frontier20 is Freedom!

PROJECT

FLOOR DESIGN

Frontier20 African Beige - 24"x48"

Frontier20 African Beige - 12"x48"

Frontier20 African Beige - 24"x24"

Frontier20 African Beige - 12"x24"

Frontier20 African Beige Stair Tread - 12"x24"

Frontier20 African Beige Riser - 8"x24"

Frontier20 Soul Walnut - 12"x48"



EASY TO INSTALL

EASY TO KEEP CLEAN
Mild environmentally friendly detergents can be used when cleaning your porcelain pavers. Pressure washers up to 1500 PSI may be used without fear of etching or striping.



ANTISLIP
The structure and texture of the porcelain paver reduce the risk of slipperiness.



RESISTANT TO MOSS AND MOLDING
Landmark Frontier20 is so dense that mold and mildew are not able to establish themselves in a permanent way making removal very easy and simple.

EASY TO REPLACE AND REMOVE
When not mortared down or installed with adhesive Landmark's Frontier20 can be easily removed and repositioned in a new area.



DRIVE OVER*
When properly installed over concrete, Landmark Frontier20 porcelain pavers are suitable for light residential vehicular traffic.
(*) When installed over reinforced concrete (4" minimum) using a thinset mortar suitable for porcelain paver.



STAIN RESISTANT
Landmark's Frontier20 porcelain pavers are virtually non porous. Due to the baked on glazing process nothing can be absorbed including stains.



RESISTANT TO THERMAL SHOCK
Landmark's porcelain pavers are baked at temperatures up to 2300 degrees F which in turn causes a very strong molecular bond making for a very dense material. Due to its density it becomes very inert allowing for extreme and sudden temperature changes in the range of - 60 F +140 F.

SCRATCH RESISTANT
Landmark Frontier20 porcelain pavers are extremely hard with an equally hard surface making them virtually scratch proof.

FADE RESISTANT
Landmarks Frontier20 baked on graphics are created using ingredients that are completely unaffected by the sun ensuring enjoyment of your porcelain paving investment for many years to come.

FROST RESISTANT
Landmark Frontier20 porcelain pavers are so dense that frost and or freezing temperatures do not affect it.

RESISTANT TO SALTS
Landmark Frontier20 porcelain pavers are completely unaffected by use of salts.

RESISTANT TO ACID AND CHEMICALS
Landmark Frontier20 is made with inert ingredients that do not react or accept acids and or chemicals allowing you to make environmentally friendly cleaning decisions!

ECO-FRIENDLY
Landmark Frontier20 porcelain pavers are produced in our environmentally friend complex following the strictest state and federal regulations. Because of Landmarks environment friendly commitment, we can incorporate up to 20% recycled content in our usa made porcelain pavers.

NO SEALING NEEDED
No sealers are needed because Landmark Frontier20 is so dense virtually nothing can stick to it!

SAVING OVER TIME
Low maintenance cost.

FOR RESIDENTIAL.

- Walkways
- Driveways
- Courtyards
- Paths on grass or gravel
- Garages
- Patios and porches
- Terraces and balconies
- Access ramps
- Verandas
- Outdoor pools

PROJECT

FLOOR DESIGN

- Frontier20 Michelangelo Extra White - 24"x48"
- Frontier20 Michelangelo Extra White - 12"x48"
- Frontier20 Michelangelo Extra White - 24"x24"
- Frontier20 Michelangelo Extra White - 12"x24"
- Frontier20 Michelangelo Extra White Stair Tread - 12"x24"
- Frontier20 Michelangelo Extra White Riser - 8"x24"

WALL DESIGN

- Veneer World Alpine Alaska - 6"x24"

FOR PUBLIC SPACES.

- Public outdoor areas
- Swimming pools
- Outdoor restaurants
- Outdoor bars
- Wellness centres
- Urban design
- Safety passages
- Outdoor pavements and squares

PROJECT

FLOOR DESIGN

Frontier20 Star Grey - 24"x48"
Frontier20 Star Grey - 12"x48"
Frontier20 Star Grey - 24"x24"
Frontier20 Star Grey - 12"x24"
Frontier20 Star Grey - 12"x12"
Frontier20 Star Grey Grip Stair Tread - 12"x48"
Frontier20 Star Grey Riser - 6"x48"

FIRE PIT DESIGN

Frontier20 Star Grey - 12"x48"

CONTINUITY IN & OUT.

Combining the Frontier20 line of products with the standard thickness product lines offers **high-level design flexibility and customization**, allowing designers and architects to easily transition inside design into outdoor beauty, functionality and performance.

PROJECT

FLOOR DESIGN
Frontier20 Modern Grey - 24"x24"

≅ 20mm THICKNESS PORCELAIN PAVERS

Landmark Ceramics provides matching solutions for indoors and outdoors, combining products from the Frontier20 catalog with items from traditional thickness collections.

Continuity of style allows architects and designers to easily transition from inside beauty to outdoor functionality.

INDOOR PORCELAIN TILE

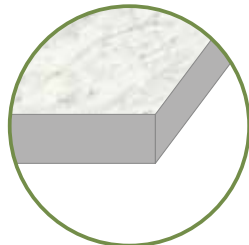

≅ 9 mm

OUTDOOR PORCELAIN PAVER

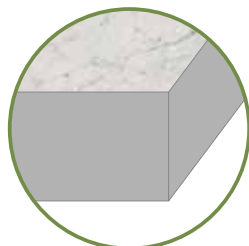

≅ 20mm



**VERSATILE
MATCHING
SOLUTIONS.**

COMPLETE LAYING VERSATILITY.

The Frontier20 product line is so simply perfect, elegant and functional, that the challenge of installation is not “How can I install Frontier20?” but rather, “Where else do I want to install Frontier20?”. Frontier20 may be installed using the traditional mortared bed, the more modern over sand and limestone, to the eco friendly permeable method, or even the budget conscious elevated deck or pedestal application.

PROJECT

OUTDOOR FLOOR DESIGN

Frontier20 Travertine Cross Cut White - 24"x48"
Frontier20 Travertine Cross Cut White - 24"x24"
Frontier20 Travertine Cross Cut White - 12"x24"
Frontier20 Travertine Cross Cut White - 12"x12"
Frontier20 Travertine Cross Cut White Grip Stair Tread - 12"x24"
Frontier20 Travertine Cross Cut White Riser - 8"x24"

WALL DESIGN

Brick World Soho Black - 3"x12"
Frontier20 Travertine Cross Cut White - 24"x48"

INDOOR FLOOR DESIGN

Charme Calacatta Gold - 24"x48"

FLOWER BEDS

Frontier20 Travertine Cross Cut White - 24"x48"

INDOOR FLOOR & WALL DESIGN

Charme Calacatta Gold - 24"x48"

01

DRY LAYING.

A way of laying pavers that allows you to **support plates** directly onto grass, gravel or sand.

01.1 ON GRASS



01.2 ON GRAVEL



01.3 ON SAND



02

INSTALLATION OVER REINFORCED CONCRETE*.

A way of laying pavers that allows you to create **perfectly stable surfaces** of incredible resistance.

* When installed over reinforced concrete (4" minimum) using a thinset/thickset mortar suitable for porcelain paver.



03

INSTALLATION OVER DECKING.

Traditional deck made with wood and porcelain pavers.



04

RAISED FLOORS.

Slabs matched with a support structure for raised high-performing floors that also leaves sufficient room for **under-floor inspection**.



01 DRY LAYING.

ADVANTAGES.

- RAPID
- MODIFIABLE
- REUSABLE
- EASY TO CARRY THROUGH
- REDUCES ADHESIVES COSTS
- QUICK TO INSTALL

The surface in 20mm thickness can be laid onto the substrate **without adhesives**, lending itself to applications onto **grass, gravel and sand**. Sought-after ambiance in the home come to life quickly with **incredible ease and simplicity**.

→ READY TO USE LOCATIONS.

- PRIVATE GARDENS
- PATIOS
- WALKWAYS
- PUBLIC PARKS AND GARDENS
- OUTDOOR COMMERCIAL AREAS
- BEACH RESORTS



DRY LAYING ON GRASS



PROJECT

FLOOR DESIGN

- Frontier20 Travertine Cross Cut Noce - 24"x24"
- Frontier20 Travertine Cross Cut Noce Coping - 24"x12"
- Frontier20 Travertine Cross Cut Noce Coping Corner - 24"x12"

WALL DESIGN

- Spirit Old Maple - 8"x40"

01.1 DRY LAYING ON GRASS.

DRY LAY OVER GRASS (PEDESTRIAN FOOT TRAFFIC)

PRACTICAL INSTALLATION

Follow the drawing below.

- Cut grass in desired area as short as possible. remove any debris.
- Using a landscape rake scratch up top 1 inch of soil and level.
- Insure sub grade is graded to a 1" in 10' slope and that it is pitched away from any building.



A FRONTIER20 PORCELAIN 3/4" NOMINAL (20MM) PAVERS

B BARE SOIL IS BEST. SCRATCH AND LAYEL WITH A RAKE

The stratigraphic images are just an example of the type of application and technical features of Frontier20. Landmark Ceramics recommends to refer to the specific norms valid in the various countries to carry out a state-of-the-art installation. Download Landmark Frontier20 Installation guide from outdoor.landmarkceramics.com for practical installation information.

DRY LAY OVER GRASS ON COMPACTED ROAD BASE INSTALLATION (PEDESTRIAN FOOT TRAFFIC)

PRACTICAL INSTALLATION

Follow the drawing below.

- Compacted base road is composed of ¾ compacted gravel.
- Sand bed course poured onto compacted gravel and screed to have smooth surface.

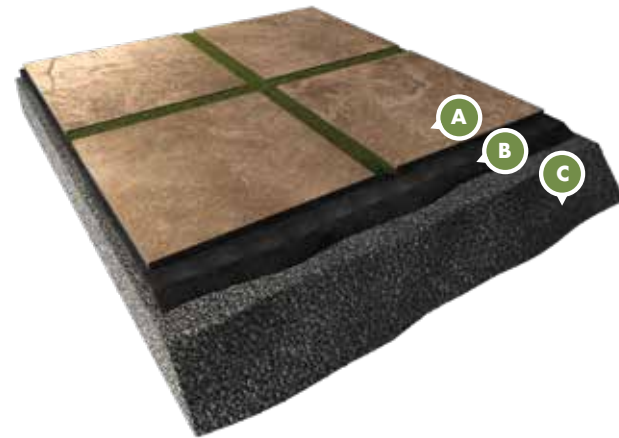

A FRONTIER20 PORCELAIN ¾" NOMINAL (20MM) PAVERS.

B 1" SAND BEDDING COURSE SCREED WITH SMOOTH SURFACE.

C COMPACTED ROAD.

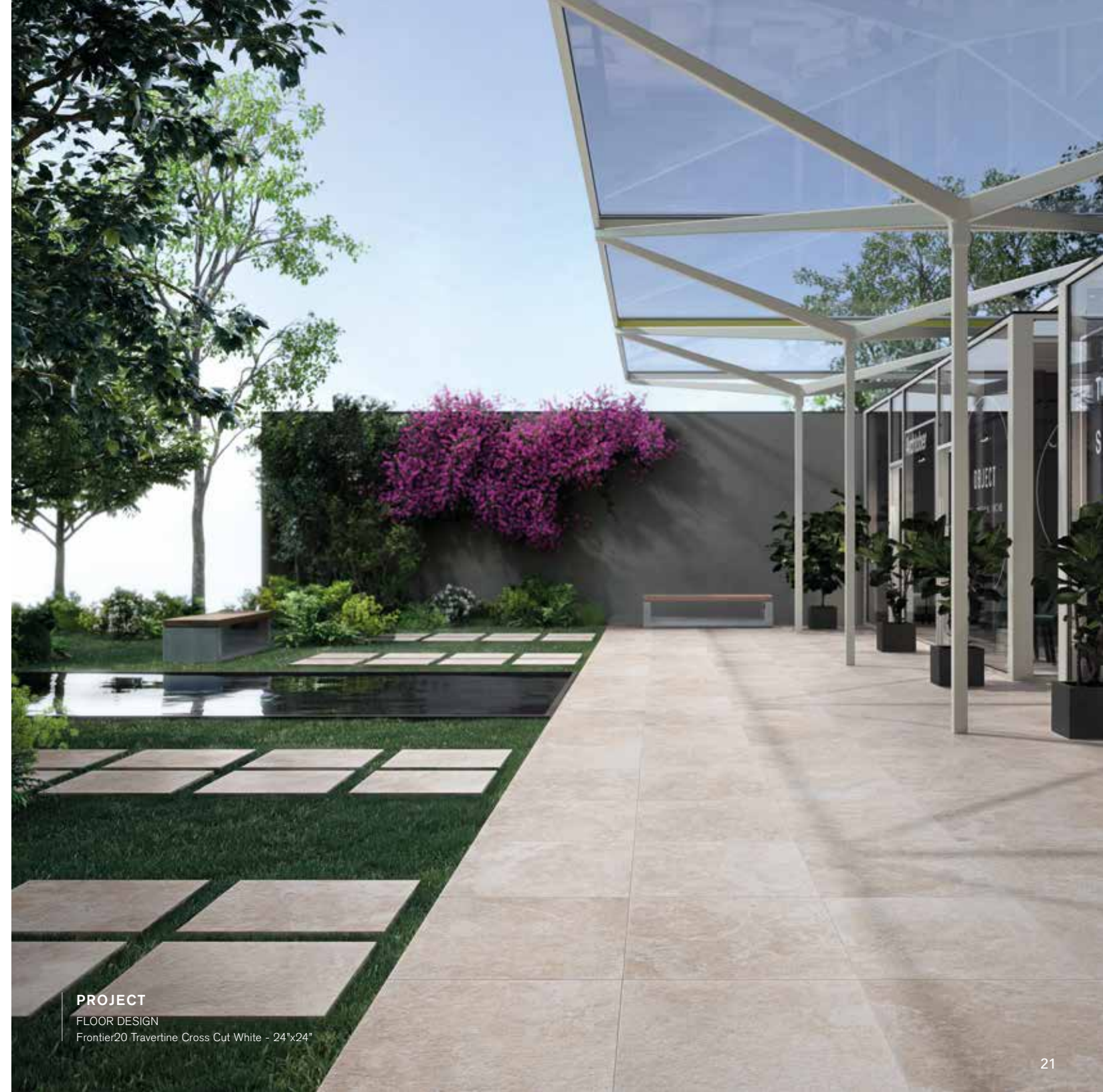

PROJECT

FLOOR DESIGN

Frontier20 Travertine Cross Cut White - 24"x24"

01.2 DRY LAYING ON GRAVEL.

PERMEABLE APPLICATION (PEDESTRIAN FOOT TRAFFIC)

PRACTICAL INSTALLATION

Follow the drawing below.

- The required edge restraint system for this installation has a vertical height of 2" (5 cm) as shown in the drawing.
- Insure that pavement is constructed with a 1" in 10' and that it is pitched away from any building.
- Insure the 3/16" (4 mm) spacers are installed between all pavers, in order to prevent pavers from touching each other (and potentially chipping) and to allow better water drainage.



- A** FRONTIER20 PORCELAIN 3/4" NOMINAL (20MM) PAVERS
- B** COARSENESS OF GRAVEL 2" - 8 S' AND 9 S' (1/2" + LESS)
- C** COARSENESS OF GRAVEL 4" - #57 (3/4")
- D** COARSENESS OF GRAVEL 6" - 3 S' - 4 S' IF DESIRED
- E** FILTER FABRIC

INSTALLATION WITH HIGH DENSITY PANELS (PEDESTRIAN FOOT TRAFFIC)

PRACTICAL INSTALLATION

Follow the drawing below.

- The edge restraint system is 0.75" - 1" height profile.
- Attach the edge restraint into the panel.
- Lay fabric directly on top of the substrate to contain sand.
- Install panel onto sand bed course 1".
- Insure the 3/16" (4 mm) spacers are installed between all pavers, in order to prevent pavers from touching each other (and potentially chipping) and to allow better water drainage.

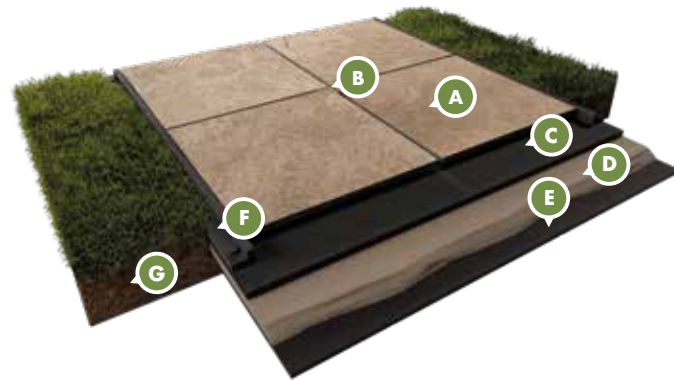

- A** FRONTIER20 PORCELAIN 3/4" NOMINAL (20MM) PAVERS
- B** SPACERS
- C** HIGH DENSITY PANELS
- D** SAND 1/2" - 1"
- E** FILTER FABRIC
- F** 1" INCH PERIPHERAL ANCHOR
- G** SUBSTRATE

WARNING:
Please remember that high density panel can reduce the heat dispersion accumulated by pavers exposed to direct sun or any other source of heat. For this reason we recommend to contact landmark ceramics at outdoor.landmarkceramics.com/contact.php for any questions you might have.

INSTALLATION WITH GRATE FULFILLED WITH SAND OVER COARSE (PEDESTRIAN FOOT TRAFFIC)

PRACTICAL INSTALLATION

Follow the drawing below.

- Paver joints have to be swept with polymeric tile sand
- Please ensure that grate has to be filled with drainable sand
- Depth of coarse aggregate has to be approximately 50% of traditional excavation vertical extent.



- A** FRONTIER20 PORCELAIN 3/4" NOMINAL (20MM) PAVERS
- B** SPACERS
- C** FILTER FABRIC
- D** GRATE SYSTEM FILLED WITH DRAINABLE SAND
- E** COARSE AGGREGATE (67 OR 57)
- F** ADDITIONAL FILTER FABRIC IF NEEDED
- G** SUBSTRATE
- H** 1" INCH PERIPHERAL ANCHOR



Insure the plastic 3/16" (4 mm) spacers are installed at all corners of the installed pavers, in order to prevent pavers from touching each other (and potentially chipping) and to allow better water drainage.

The stratigraphic images are just an example of the type of application and technical features of Frontier20. Landmark Ceramics recommends to refer to the specific norms valid in the various countries to carry out a state-of-the-art installation. Download Landmark Frontier20 Installation guide from outdoor.landmarkceramics.com for practical installation information.

01.3 DRY LAYING ON SAND.

TYPICAL FLEXIBLE BASE INSTALLATION (PEDESTRIAN FOOT TRAFFIC)

PRACTICAL INSTALLATION

Follow the drawing below.

- Base material is to be over dug 6" to 8" beyond the edge of the pavement.
- The required edge restraint system is a low profile edge restraint with a vertical height of 1.5" (4 cm) as shown in the drawing.
- Insure that pavement is constructed with a 1" in 10' slope that it is pitched away from any building.
- Insure the plastic 3/16" (4 mm) spacers are installed at all corners of the installed pavers, in order to prevent pavers from touching each other (and potentially chipping) and to allow better water drainage.



A FRONTIER20 PORCELAIN
3/4" NOMINAL (20MM) PAVERS

C 4-6" CRUSHER RUN/ROAD BASE

B 3/4" UNCOMPACTED BEDDING SAND

D FILTER FABRIC

OVER SAND BASE INSTALLATION (PEDESTRIAN FOOT TRAFFIC)

PRACTICAL INSTALLATION

Follow the drawing below.

- Filter fabric is recommended as it allows water to pass but not the particles of sand.
- 2-4" of a compactable sand is recommended. You can go with more however it will not offer any distinct advantage. Going with less than 2" may offer a less desirable effect as it will tend to hold more water and become "mushy" when super saturated.
- The use of an edge restraint is ideal but not necessary. It becomes more necessary if your desired paving area is above the surrounding native soil, as it will help aid in the minimization of sand migration or erosion.
- Insure the plastic 3/16" (4 mm) spacers are installed at all corners of the installed pavers, in order to prevent pavers from touching each other (and potentially chipping) and to allow better water drainage.



A FRONTIER20 PORCELAIN
3/4" NOMINAL (20MM) PAVERS

B APPROX. 4" OF
BEDDING SAND

C FILTER FABRIC

SAND SET OVER CONCRETE (PEDESTRIAN FOOT TRAFFIC)

PRACTICAL INSTALLATION

Follow the drawing below.

- The edge restraint system is 1 1/2" - 2" height profile.
- Ensure edge restraint into the concrete base made.
- Lay fabric directly on top of the concrete to contain sand and fold it up the front of the edging.
- Insure that pavement is constructed with a 1" in 10' and that it is pitched away from any building.
- Insure the 3/16" (4 mm) spacers are installed between all pavers, in order to prevent pavers from touching each other (and potentially chipping) and to allow better water drainage.



A FRONTIER20 PORCELAIN
3/4" NOMINAL (20MM) PAVERS

B SAND BEDDING COURSE 1"

C FILTER FABRIC

D EXISTING OR NEW
CONCRETE 4" MINIMUM

E 1/2" - 1" INCH DRAINAGE HOLES
DRILLED 24 INCH ON CENTER

F PERIPHERAL RESTRAINT SYSTEM



Insure the plastic 3/16" (4 mm) spacers are installed at all corners of the installed pavers, in order to prevent pavers from touching each other (and potentially chipping) and to allow better water drainage.

The stratigraphic images are just an example of the type of application and technical features of Frontier20. Landmark Ceramics recommends to refer to the specific norms valid in the various countries to carry out a state-of-the-art installation. Download Landmark Frontier20 Installation guide from outdoor.landmarkceramics.com for practical installation information.

02 INSTALLATION OVER REINFORCED CONCRETE*

The Frontier20 may also be installed with traditional methods using thinset/thickset mortar appropriate for use with porcelain paver. In a short 24 hours your floor will be ready for foot traffic. This method offers the most stable and most durable floor covering that is able to withstand foot traffic up to light vehicular traffic.

* It is recommended installation over 4" minimum thick reinforced concrete, using a thinset/thickset mortar suitable for porcelain paver.

ADVANTAGES.

- LONG TERM DURABILITY
- READILY ACCESSIBLE SURFACES
- ABLE TO WITHSTAND PEDESTRIAN AND LIGHT VEHICLE TRAFFIC

LOCATIONS.

- YARDS
- PORCHES
- TERRACES
- RAMPS
- GARAGES
- PARKING AREAS
- CYCLE TRACKS
- PAVEMENTS
- SQUARES



INSTALLATION OVER REINFORCED CONCRETE

THIN SET MORTAR APPLICATION OVER REINFORCED CONCRETE

PRACTICAL INSTALLATION

Follow the drawing below.

- Insure that pavement is constructed with approximately 2 degree slope and that it is sloped away from any building.
- Please consult your paver supply distributor for thin set mortar suitable for porcelain paver as well as for inside or external usage.
- For cementitious adhesive and grout installation, refer to the manufacturer's technical instructions and specifically as they relate to outdoor installations.
- For concrete foundation slabs that are not large enough to require contraction/control joints, a minimum $\frac{3}{16}$ " (4 mm) grout joint is acceptable, but for larger concrete foundation slabs that do require contraction/control joints, the control joint width should be a $\frac{3}{8}$ " (1 cm). It is absolutely imperative that all contraction/control joints be located in the joint line of installed porcelain pavers and not beneath a paver.

CAUTION: if a porcelain paver is installed over a control joint, the paver will reflectively crack along the contraction/control joint beneath it.

Utilization of an uncoupling membrane can help minimize the potential issue.

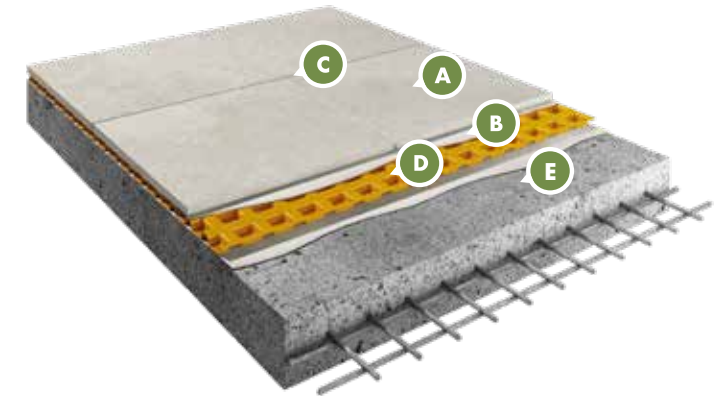

- A** FRONTIER20 PORCELAIN 3/4" NOMINAL (20MM) PAVERS
- B** THINSET
- C** 3/16" MINIMUM GROUT JOINT
- D** UNCOUPLING MEMBRANE
- E** EXISTING OR NEW CONCRETE (REINFORCED). 4" MINIMUM

The stratigraphic images are just an example of the type of application and technical features of Frontier20. Landmark Ceramics recommends to refer to the specific norms valid in the various countries to carry out a state-of-the-art installation. Download Landmark Frontier20 Installation guide from outdoor.landmarkceramics.com for practical installation information.



03 INSTALLATION OVER DECKING.

Landmark Ceramic's Frontier20 combined with a **grate system** allows porcelain paving to be utilized in conjunction with an existing or new construction **wood deck structure**. As long as the wooden deck structure is constructed soundly and according to local codes, the honeycomb plastic grate is installed as the substrate for the porcelain paver. This system is **highly innovative and functional** for the design of contemporary outdoor spaces.



ADVANTAGES.

- ANTISLIP FROST RESISTANT
- RESISTANT TO THERMAL SHOCK
- SAFETY
- EASY TO MAINTAIN
- DURABLE OVER TIME
- HIGH END LOOK
- NEVER HAVING TO STAIN DECK BOARDS AGAIN
- NO SCREW OR NAILS STICKING UP
- NO WOOD SPLINTERS

LOCATIONS.

- PRIVATE GARDENS
- OUTDOOR ELEVATED WALKWAYS
- DECK PATIOS
- DECK GAZEBOS



INSTALLATION OVER DECKING

INSTALLATION OVER DECKING (PEDESTRIAN FOOT TRAFFIC)

PRACTICAL INSTALLATION

Follow the drawing below.

- Deck joists must be "sound" and in good condition as well as constructed in accordance with local codes.
- Deck joists must be spaced 16" on center.
- Top of joists must be flat to one another.
- Grates will span 2 joists and be fastened using weather proof screws.
- Stagger grates $\frac{1}{3}$ rd, $\frac{1}{4}$ th or $\frac{1}{2}$ as shown.
- Outdoor fabrics varies in thickness. Multiple layers may be needed to reduce acoustics.
- The use of porcelain paver spacers are recommended. $\frac{1}{8}$ th inch joints are the minimum recommendation.
- Silicon or a neutral colored adhesive may be applied to spacers to help reduce porcelain paver movement.
- Porcelain paver joints may be filled or left open, depending on desired drainage.
- Insure the $\frac{3}{16}$ " (4 mm) spacers are installed between all pavers, in order to prevent pavers from touching each other (and potentially chipping) and to allow better water drainage.



- A** FRONTIER20 PORCELAIN 3/4" NOMINAL (20MM) PAVERS
- B** OUTDOOR FABRIC OR SOUND INSULATING MATTRESS
- C** HONEYCOMB PLASTIC GRATE
- D** DECK JOISTS

Insure the plastic 3/16" (4 mm) spacers are installed at all corners of the installed pavers, in order to prevent pavers from touching each other (and potentially chipping) and to allow better water drainage.

The stratigraphic images are just an example of the type of application and technical features of Frontier20. Landmark Ceramics recommends to refer to the specific norms valid in the various countries to carry out a state-of-the-art installation. Download Landmark Frontier20 Installation guide from outdoor.landmarkceramics.com for practical installation information.

04 RAISED FLOORS.

In combination with a suitable structure the **Frontier20 porcelain paver** in 20mm thickness lend themselves perfectly to floors with a **suspended installation**. The adjustable stand means being able to create an air space under the floor in which to lay electrical conduit or plumbing. The raised flooring system is easy to manage, allows you to configure the underlying wiring or plumbing systems based on specific needs and also to change its configuration any time a new look is needed.

ADVANTAGES.

- LEVEL OFF UNEVEN SURFACES
- ALLOWS YOU TO HIDE UNSIGHTLY PIPES AND PLANTS WIRES AND ELECTRICAL CONDUIT
- EASY MAINTENANCE
- ALLOWS FOR WATER DRAINAGE
- RESISTANT TO THERMAL EXPANSION
- PROVIDES THERMAL AND ACOUSTIC INSULATION
- NO NEED FOR ADHESIVES
- REDUCES LABOUR COSTS

LOCATIONS.

- PATIOS
- GAZEBOS
- FACILITY AREAS OF COMMERCIAL VENUES
- ROOF TOPS



LOW HEIGHT SUPPORTS (UP TO 3/4" - 20MM) PEDESTAL INSTALLATION OVER EXISTING SUBSTRATE

(PEDESTRIAN FOOT TRAFFIC)

PRACTICAL INSTALLATION

Follow the drawing below.

- Ensure concrete slab is in stable condition and has a 1" in 10' slope to divert water away from structure.
- Ensure spacer tabs are intact in the corners where the porcelain pavers might come to contact.



- A** FRONTIER20 PORCELAIN 3/4" NOMINAL (20MM) PAVERS
- B** PEDESTAL
- C** EXISTING SLAB OR SUBSTRATE

Ensure the plastic 3/16" (4 mm) spacers are installed at all corners of the installed pavers, in order to prevent pavers from touching each other (and potentially chipping) and to allow better water drainage.

The stratigraphic images are just an example of the type of application and technical features of Frontier20. Landmark Ceramics recommends to refer to the specific norms valid in the various countries to carry out a state-of-the-art installation. Download Landmark Frontier20 Installation guide from outdoor.landmarkceramics.com for practical installation information.

INSTALLATION OVER LOW HEIGHT SUPPORTS (UP TO 3/4" - 20MM) PEDESTAL ON CONCRETE

(PEDESTRIAN FOOT TRAFFIC)

PRACTICAL INSTALLATION

Follow the drawing below.

- Make sure the concrete slab is properly built and smooth and has 1 1/2 - 2 degree pitch and that it is pitched away from any building.
- Plastic 3/4" pedestal support must be placed and installed all corners of the pavers.



- A** FRONTIER20 PORCELAIN 3/4" NOMINAL (20MM) PAVERS
- B** PEDESTAL
- C** CONCRETE BASE
- D** SUBSTRATE

RAISED FLOORS INSTALLATION SYSTEM.

LOW HEIGHT SUPPORTS.

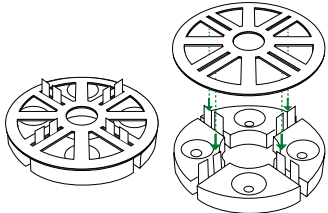

System made up of disks of variable thickness. Utilize for low height installation (up to 3/4").

	AVAILABLE HEIGHT			
	1/8"	1/4"	1/2"	3/4"
	1/8"			



ADJUSTABLE HEIGHT SUPPORTS.

System made up of adjustable height pedestal (from 1 1/4" to 16").

	AVAILABLE HEIGHT			
	1 1/4" - 2"	2" - 3"	3" - 4 3/4"	4 3/4" - 7 3/4"
	add up 4" each			
	0" - 1" per foot slope			

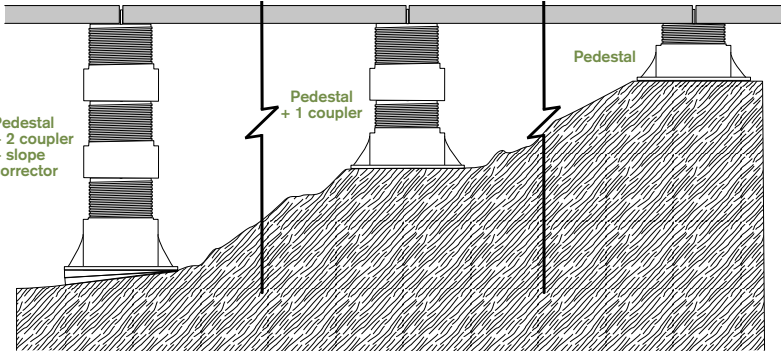

RAISED FLOORS INSTALLATION SYSTEM.

20 THICKNESS
PORCELAIN PAVERS

WARNINGS.

It is recommended to carry out raised installation onto a solid, resistant substrate with the correct inclination to guarantee water drainage. Support come equipped with four spacers that allow for the creation of grout lines between pavers. For a correct installation against walls or corners, it is necessary to keep the supports distant from the wall and remove 2 or 4 spacers as showed in the picture below. Landmark Ceramics recommends to strictly follow the instructions for the raised installation of Frontier20. Failure to comply with these recommendations may lead to improper use of the product and could cause serious property damage or injury. For further information and recommendations concerning the installation systems please refer to our website at <https://outdoor.landmarkceramics.com>.

Wall corner

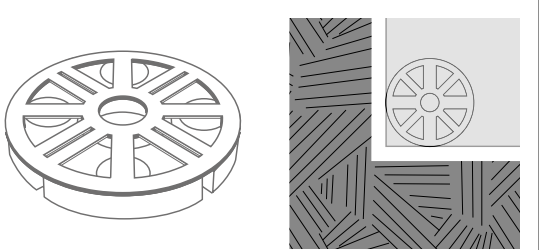

Wall border

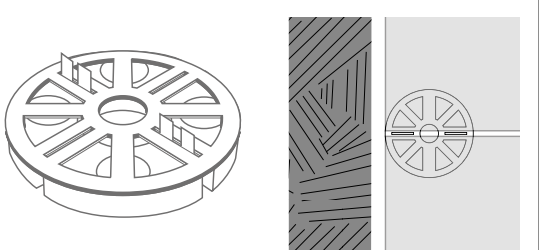

Floor center

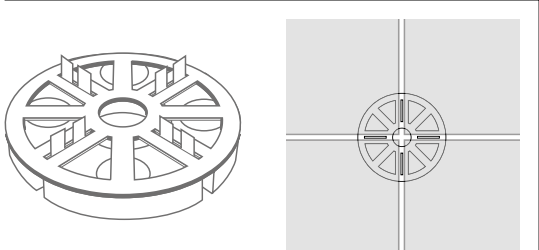

24"x24" - 12"x24" - 12"x12"

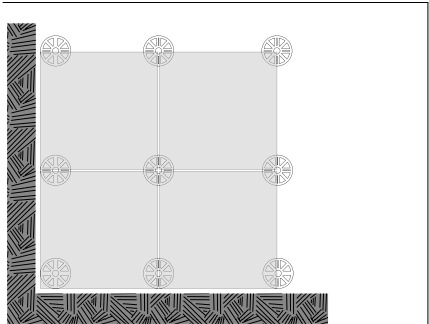

12"x48"

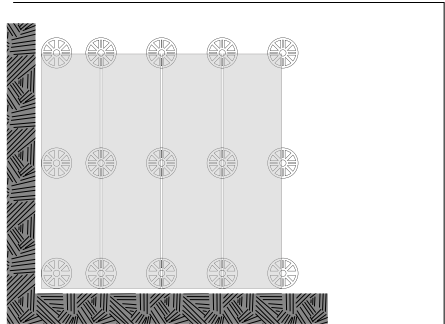

24"x48"

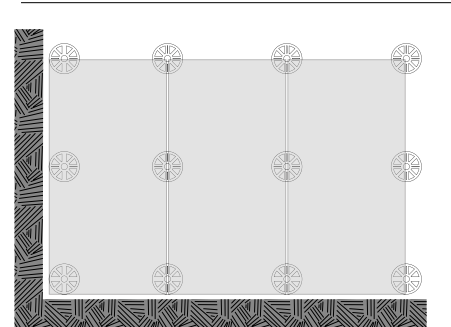

RAISED FLOORS INSTALLATION SYSTEM.

WARNINGS.

Landmark products are made using the best technology available, and their technical performances match or exceed requirements from both ASTM and ISO standards for porcelain products.

Nevertheless, if the application of the 20 mm slabs requires the ceramic product used in structural installations, the project engineer and/or customer must carefully assess the project requirements with regard to the technical specifications of the slabs.

To prevent the risk of damage or injury, the manufacturer recommends:

- With regard to a raised floor installation a ceramic slab may fracture on impact if a heavy object falls on it. Therefore, the manufacturer recommends checking the specific intended use before starting the installation and:

- 1) As far as supports requirements, comply with the table for raised installation provided below.
- 2) In all installations on pedestals higher than 3/4", reinforcing must be applied on the back of the slabs (double fiberglass mesh) supplied and applied by the manufacturer.

SUPPORTS REQUIREMENTS			
	SIZE	UP TO 3/4" (20MM)	ABOVE 3/4" (20MM)
	12"x12" (300x300 mm)	4 supports 0,32 pcs/sq ft	Please contact Landmark Ceramics
	12"x24" (600x300 mm)	4 supports 0,32 pcs/sq ft	Please contact Landmark Ceramics
	24"x24" (600x600 mm)	4 supports 0,32 pcs/sq ft	Please contact Landmark Ceramics
	24"x36" (600x900 mm)	6 supports 0,32 pcs/sq ft	Please contact Landmark Ceramics
	12"x48" (300x1200 mm)	6 supports 0,65 pcs/sq ft	Please contact Landmark Ceramics
	24"x48" (600x1200 mm)	6 supports 0,65 pcs/sq ft	Please contact Landmark Ceramics

- With reference to any dry installation system of flooring above the ground level, the manufacturer recommends to comply with local regulations and conditions of use with regard to wind-load, loadbearing, seismic events, etc.
- Outdoor pavings installed unglued above the ground level are subject to the action of the wind, with the risk, in some cases, of becoming airborne. The manufacturer recommends to require the assistance of a qualified professional in order to check the suitability of the installation system above the ground adopted, in accordance with the local laws and regulations and the conditions of use.

NOTE.

For any detail and technical specification concerning the double fiberglass mesh, please contact Landmark Ceramics. Landmark is responsible only if it supplies the whole system (paver + double fiber mesh). Landmark cannot be held responsible for reinforcing systems not supplied by Landmark.

In case of breakage, paver must be replaced immediately.

PORCELAIN PAVERS OTHER WARNINGS

Outdoor pavings installed unglued above the ground level are subject to the action of the wind, with the risk, in some cases, of becoming airborne. The manufacturer recommends to require the assistance of a qualified professional in order to check the suitability of the installation system above the ground adopted, in accordance with the local laws and regulations and the conditions of use. Failure to do so could result in serious injury or property damage.

If the application of the 20 mm slabs requires the ceramic product used in structural installations, the project engineer and/or customer must carefully assess the project requirements with regard to the technical specifications of the slabs. With reference to a raised floor installation: a ceramic slab may fracture on impact if a heavy object falls on it from any significant height. Therefore to prevent the risk of damage or injury, Landmark recommends to check the specific intended use before starting the installation and to follow table for raised installation provided below. In certain conditions, reinforcing must be applied on the back of the slabs (double fiberglass mesh) supplied and applied by the Landmark. With reference to any dry installation system of flooring above the ground level: Landmark recommends to comply with local regulations and conditions of use with regard to wind- load, loadbearing, sismic events, etc. Failure to comply with these recommendations may lead to improper use of the product and could cause serious damage or injury. Failure to adhere to Landmark's instructions for installation of slabs on raised pedestal systems may result in serious injury.

For further information and recommendations concerning the installation systems please refer to <https://outdoor.landmarkceramics.com> website.

All the information provided in this document can be subject to change. Please refer to our websites (<https://www.lcusa.com> and <https://outdoor.landmarkceramics.com>) for the latest, most accurate and up-to-date information.

RECOMMENDATIONS FOR THE INSTALLATION, ORDINARY CLEANING AND MAINTENANCE OF FRONTIER20.

Landmark Ceramics recommends carrying out the procedures for the ordinary cleaning of Frontier20 floor surfaces using water and commercially available neutral detergents: the inclination of the surface and the space between adjacent slabs for dry-system installation favour the natural flow of water. However, it is important to take into consideration that any type of floor surface is subject to the surface tension effect of liquids: it is the same property of water that gives the tendency to transform into spherical droplets and which cause the curved top surface of a glass full of water. The surface tension can obstacle the complete drainage of water and cause a temporary stagnation of liquid on the slab edges. In order to avoid this problem, Landmark Ceramics recommends ensuring adequate inclination of the surface during installation so as to encourage the flow of water between adjacent slabs. Please remember in any case that, in view of the distinctive advantages of porcelain stoneware, Frontier20 absorbs practically no water, which makes it highly frost-proof. This may lead to localised water pooling, mainly on the edges of the pavers, independently of the manner and quality of the laying. Laying is also recommended with a minimum gap of 4 mm (5/32"). Should liquid deposit on the surface, it is recommended to push it towards grout lines using a brush or remove it with a wet and dry vacuum cleaner.



Backing with double fiberglass mesh.

TRIM TILES TO LANDSCAPE THE OUTDOORS.

Frontier20 includes a complete range of **special trim pieces** to seamlessly complete and accentuate the landscaping of outdoor spaces. The trim tiles represent the ideal solution for the planning of outdoor spaces, **commercially or residentially**. The special trims feature coordinated aesthetics to match those of the **Landmark porcelain paver**, for projects that demand **total visual continuity**.

DESTINATION OF USE.

- STAIRS
- POOLS
- WALL COVERS

PROJECT

FLOOR DESIGN

- Frontier20 Silver Quartz - 24"x24"
- Frontier20 Silver Quartz Linear Cover Drain Set - 24"x24"
- Frontier20 Silver Quartz Coping - 24"x12"
- Frontier20 Silver Quartz Coping Corner - 24"x12"
- Frontier20 Silver Quartz Stair Tread - 24"x12"
- Frontier20 Silver Quartz Stair Tread Grip - 24"x12"
- Frontier20 Silver Quartz Riser - 24"x8"
- Frontier20 Silver Quartz Cover - 24"x12"
- Frontier20 Silver Quartz End Cover - 24"x12"

STAIR TREAD
P. 39

GRIP STAIR TREAD
P. 39

RISER
P. 39

END COVER
P. 43

COVER
P. 43

COPING CORNER
P. 41

COPING
P. 41

LINEAR COVER DRAIN SET
P. 41

STAIRS WITH AN IN-DEMAND AESTHETIC THAT IS ALSO HIGH PERFORMING.

SYSTEM.

- STAIR TREAD
- GRIP STAIR TREAD
- RISER

ADVANTAGES.

- RESISTANCE TO SALTS
- RESISTANCE TO CHEMICALS
- TECHNICAL PERFORMANCE
- ANTI-SLIP
- VISUAL CONTINUITY TO THE OUTDOOR FLOOR

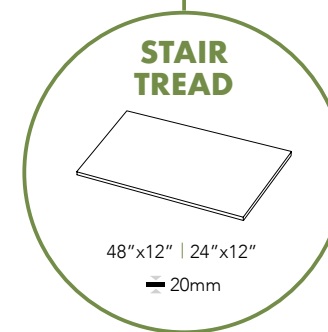
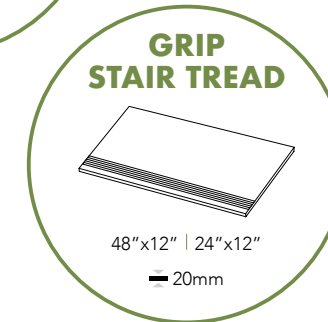
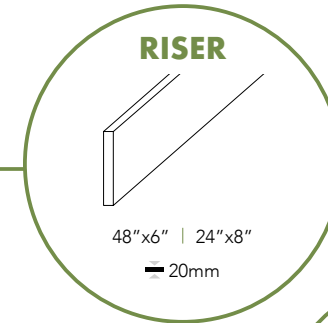

COMFORT AND STYLE FOR SWIMMING POOL AREAS.

SYSTEM.

- LINEAR COVER DRAIN SET
- COPING
- COPING CORNER

ADVANTAGES.

- RESISTANCE TO SALTS
- RESISTANCE TO CHEMICALS
- ANTI-SLIPPERINESS
- DURABILITY
- EASY TO CLEAN
- VISUAL CONTINUITY TO THE OUTDOOR FLOOR

* The Linear Cover Drain Set is made-up of two pieces, each having a further beveled and polished edge. The two pieces are studied to be laid with the beveled and polished edges facing each other in order to create an open joint. See pages 45, 46 for more details.

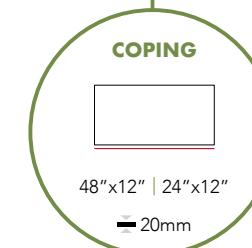
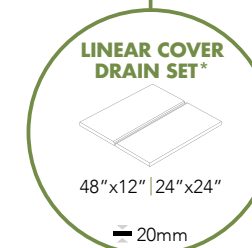
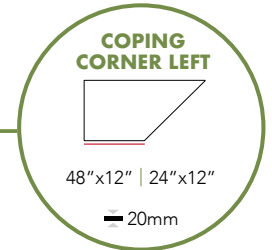
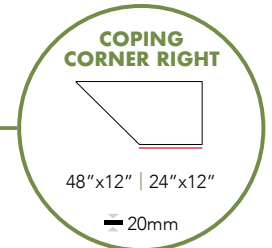
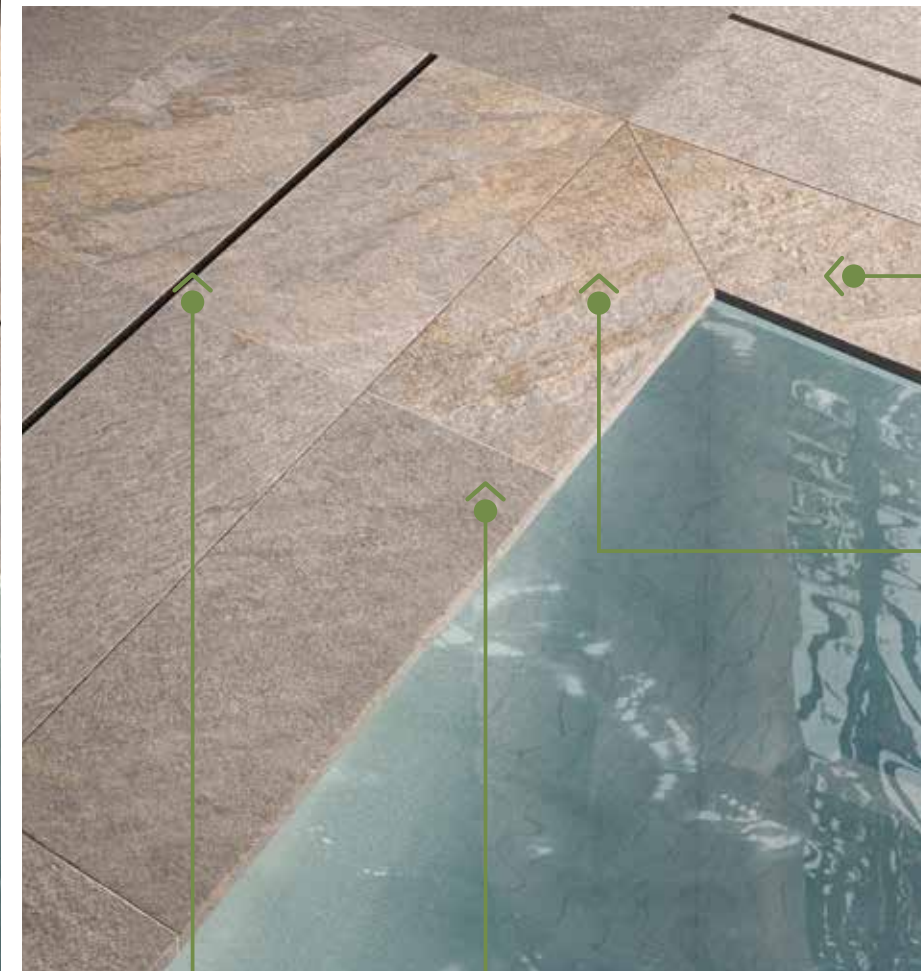

WALL COVERS: PROTECTION FROM WATER AND VISUAL CONTINUITY.

SYSTEM.

- COVER
- END-COVER

ADVANTAGES.

- ANTI-DETERIORATION
- EASY TO CLEAN
- PROTECTS THE WALL FROM WATER INFILTRATION

* Both Cover and End-Cover have dripstone and undecorated borders.



COVER *



12"x24"

20mm

END COVER *



12"x24"

20mm

DRIPSTONE

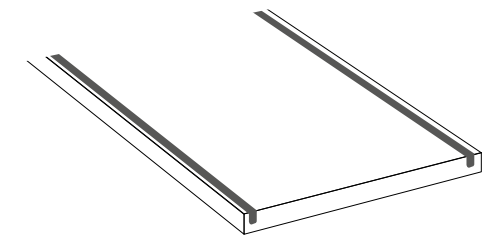

TRIM TILES RANGE 24" x 24"

STAIRS

STAIR TREAD*

TRIM DIMENSIONS

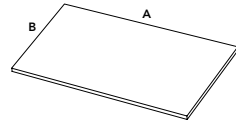

A: 24"
B: 12"



Rectified Bullnose

GRIP STAIR TREAD*

TRIM DIMENSIONS

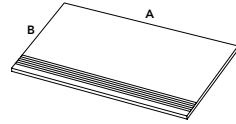

A: 24"
B: 12"



Rectified Bullnose

RISER*

TRIM DIMENSIONS

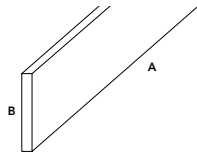

A: 24"
B: 8"



Rectified



WALL COVERS

COVER*

TRIM DIMENSIONS

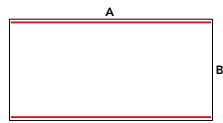

A: 24"
B: 12"

END COVER*

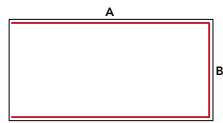

Undecorated border and dripstone



* Available in standard version (with undecorated borders).

TRIM TILES RANGE 24" x 24"

POOLS

COPING*

TRIM DIMENSIONS

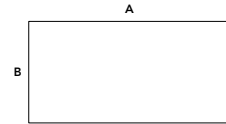

A: 24"
B: 12"



Rectified Bullnose

LINEAR COVER DRAIN SET*

TRIM DIMENSIONS

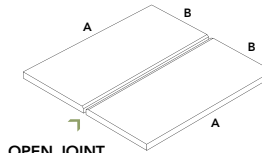

OPEN JOINT WIDTH 0.28" (1/32")

A: 24"
B: 11.63"



Open joint width 0.28" (1/32")

COPING CORNER*

TRIM DIMENSIONS

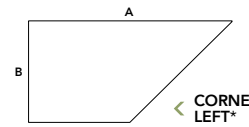

CORNER LEFT*

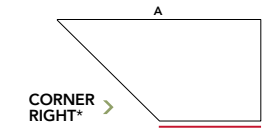

CORNER RIGHT*

A: 24"
B: 12"



Rectified Bullnose



* Available in standard version (with undecorated borders).

TRIM TILES RANGE 12"x48"

STAIRS

STAIR TREAD*

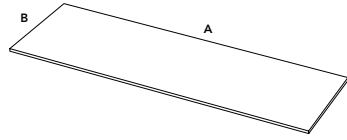

TRIM DIMENSIONS

A: 48"
B: 12"

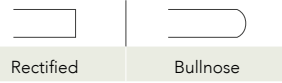

GRIP STAIR TREAD*

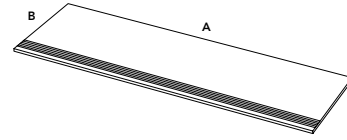

TRIM DIMENSIONS

A: 48"
B: 12"

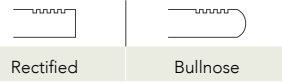

RISER*

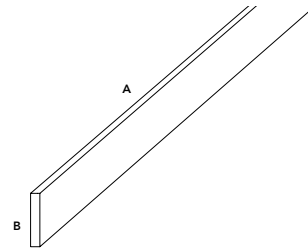

TRIM DIMENSIONS

A: 48"
B: 6"

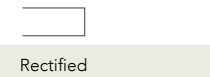

POOLS

COPING*

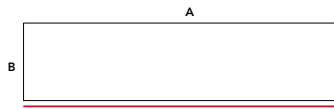

TRIM DIMENSIONS

A: 48"
B: 12"

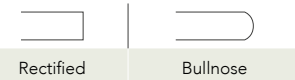

LINEAR COVER DRAIN SET*

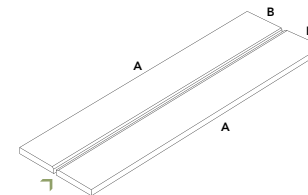

TRIM DIMENSIONS

A: 48"
B: 5.76"

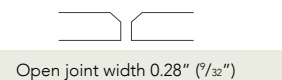

OPEN JOINT
WIDTH 0.28" (9/32")

Open joint width 0.28" (9/32")

COPING CORNER*

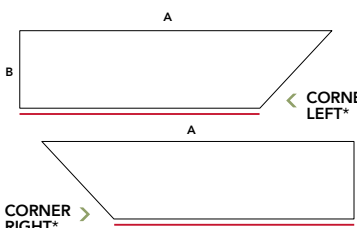

TRIM DIMENSIONS

A: 48"
B: 12"



* Available just in standard version (with undecorated borders).



PROJECT

FLOOR DESIGN
Frontier20 Full Color Bluestone Cobblestone Multisize - 24"x24"

A COMPLETE PROJECT FOR EVERY NEED.

_Frontier20 is a complete project for any design need, specially developed by Landmark for contemporary outdoor spaces. The extent of the range makes it possible to design outdoor environments with looks that are always new, and to play with surfaces inspired by different materials.

ADVANTAGES.

- 01 **WIDE LOOKS RANGE**
- 02 **A WIDE RANGE OF SIZES**
- 03 **AMERICAN STONES**
- 04 **LANDMARK DESIGN PROJECT**

PROJECT

FLOOR DESIGN

Frontier20 Travertine Cross Cut Silver - 24"x24"

WALL DESIGN

Frontier20 Travertine Cross Cut Silver - 24"x24"

COUNTER

Frontier20 Travertine Cross Cut Silver - 24"x24"

01
**WIDE LOOKS
RANGE.**

🇺🇸 5%

BLUESTONE DESIGN PROJECT



TUMBLED BLUESTONE



TUMBLED BLUESTONE
COBBLESTONE CUBE



TUMBLED BLUESTONE
COBBLESTONE MULTISIZE



BLUESTONE DESIGN PROJECT



THERMAL BLUESTONE
BLUE SELECT



BLUESTONE BLUE SELECT



BLUE SELECT BLUESTONE
COBBLESTONE CUBE



BLUE SELECT BLUESTONE
COBBLESTONE MULTISIZE



BLUESTONE DESIGN PROJECT



THERMAL BLUESTONE
FULL COLOR



BLUESTONE FULL COLOR



FULL COLOR BLUESTONE
COBBLESTONE CUBE



FULL COLOR BLUESTONE
COBBLESTONE MULTISIZE



TRAVERTINE CROSS CUT DESIGN PROJECT



TRAVERTINE
CROSS CUT WHITE



TRAVERTINE
CROSS CUT SILVER



TRAVERTINE
CROSS CUT CREAM



TRAVERTINE
CROSS CUT NOCE



FLAGSTONE BROWN



SLATE LOOK



MULTICOLOR GOLD



MULTICOLOR DARK



VINTAGE SLAB



LIMESTONE LOOK



LIMESTONE



INDIANA SALEM DESIGN PROJECT



INDIANA BUFF SELECT



INDIANA GREY SELECT



INDIANA VARIEGATED



01 WIDE LOOKS RANGE.

🇺🇸 ↻ 5%

TERRAZZO LOOK

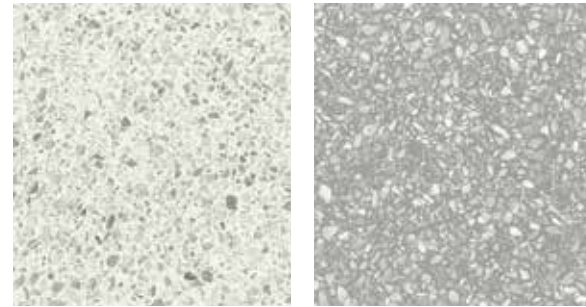

DIAMOND WHITE

FASHION GREY



STONE LOOK



COSMOPOLITAN ASH

ARTISTIC BEIGE

FASHION BLACK

ABSOLUTE

COSMOS



QUARTZITE DESIGN PROJECT



ARCTIC WHITE

AFRICAN BEIGE

STAR GREY



QUARTZ LOOK



BARGE GOLD

SILVER QUARTZ



STONE LOOK



NATURAL IVORY

MODERN GREY

SKY

DESERT

WHITE AVENUE



CONCRETE LOOK



FREEDOM WHITE

PASSION SILVER

SIMPLY GREY



LIMESTONE LOOK

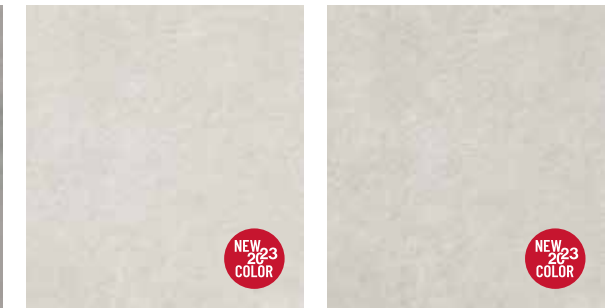

INTERNATIONAL WHITE

MINIMALIST GREIGE

NEW 2023 COLOR

NEW 2023 COLOR



MARBLE LOOK

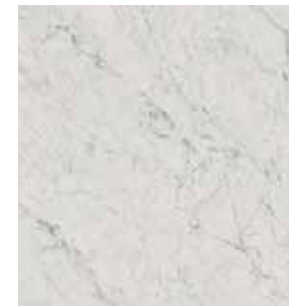

MICHELANGELO EXTRA WHITE



20mm THICKNESS
PORCELAIN PAVERS

01 WIDE LOOKS RANGE.

🇺🇸 ↔️ 5%

WOOD LOOK



WALNUT

PEPPER



V3



V3



WOOD LOOK



SOUL WALNUT

SOUL GREY

ESSENCE GREY

ESSENCE BROWN



V2



V2



V2



V2



PROJECT

OUTDOOR FLOOR DESIGN
 Frontier20 Essence Brown - 12"x48"
 Frontier20 Essence Brown Star Tread - 12"x48"
 Frontier20 Essence Brown Coping Corner - 12"x48"
 Frontier20 Essence Brown Riser - 6"x48"

02

A WIDE RANGE OF DIFFERENT SIZES.

DIFFERENT SIZES, GREATER FREEDOM.

Frontier20 is characterized by a wide range of sizes from the small 9"x9", 9"x18", 12"x12" and 12"x24" up to the bigger 24"x36" and 24"x48", from the classic 24"x24" to the refined 12"x48" plank size. Frontier20 ensures freedom in every design project.

PROJECT

OUTDOOR FLOOR DESIGN

Frontier20 Limestone - 24"x48"

Frontier20 Limestone - 12"x48"

Frontier20 Limestone - 12"x12"

Frontier20 Limestone Grip Stair Tread - 12"x48"

Frontier20 Limestone Riser - 6"x48"

WALL DESIGN

Veneer World Pro LedgeStone Alpine Alaska - 6"x24"

Frontier20 Limestone Wall Cover - 12"x24"

FLOWER BEDS DESIGN

Veneer World Pro LedgeStone Ridge Black - 6"x24"



24" x 48"



12" x 48"



24" x 24"



12" x 24"



12" x 12"



24" x 36"



9" x 18"



9" x 9"

03 AMERICANSTONE★

THE AMERICAN SOUL OF THE REAL AMERICAN STONES.



PROJECT
FLOOR DESIGN
Frontier20 Bluestone Blue Select - 24"x24"
Frontier20 Bluestone Blue Select Linear Cover Drain Set - 24"x24"

Frontier20 American Stone is a collection of some of the most regionally popular natural stones from across the nation. Elegant rangy Bluestone from the North East, earth tone tans browns from the desert south west, iconic and classic Indiana Limestone select from the Midwest in buff, grey, and variegated colorations, lastly the pacific northwest's deep charcoal slates. The American Stone range also includes prestigious travertine cut against the vein, a stone commonly found in the southwest distinguished by the timeless beauty and appeal of the original material. Naturally inspired color that are rich, sophisticated and bold enough to make a statement yet versatile enough to seamlessly blend your home's interior charm with your outdoor living area.

Unlike natural stone, American Stone is uniform in thickness and consistent in size, affording the most in design flexibility and cost saving installation. American Stone is extremely durable, will never fade, impervious to chemicals or salts, can be easily cleaned without harsh chemicals and never needs sealed. **Landmark's American Stone is freedom.**

PROJECT
FLOOR DESIGN
Frontier20 Multicolor Dark - 24"x24"



PROJECT
OUTDOOR FLOOR DESIGN
Frontier20 Full Color Bluestone Cobblestone Cube - 24"x24"
OUTDOOR WALL DESIGN
Frontier20 Bluestone Blue Select - 12"x24"
CAFETERIA COUNTER
Emotion Soft Dark - 8"x40"

04 DESIGN PROJECT.

Landmark Design Project is the newest, unique and most distinctive concept developed by Landmark. Every Design Project takes root from the study of a prestigious and popular natural stone, widely used in North America for both indoor and outdoor applications. The ultimate goal is to provide a deep and complete interpretation of that stone using porcelain technology. The reference stone is studied in depth in terms of colors, textures, finishes and sizes, with the ambitious goal to blend them into a complete and unique porcelain design project, able to match and exceed the design and application options offered by the natural stone. At the same time, BDP combines all its beauty with superior technical performances of the best porcelain. Every design project is an integrated solution perfectly balanced to design outdoor floors and walls with a stunning and elegant total stone-effect look inspired by American premium natural stones. All the items belonging to a Design Projects can be blended, allowing designers to adopt the same concept everywhere, boundlessly playing with different sizes, colors, finishes and creative patterns, as well as unique and eye-catching walls proposal and In&Out solutions.

PROJECT

OUTDOOR FLOOR DESIGN
Frontier20 Thermal Bluestone Full Color - 24"x24"
Frontier20 Thermal Bluestone Full Color Coping - 24"x12"
Frontier20 Thermal Bluestone Full Color Coping Corner - 24"x12"
Frontier20 Full Color Bluestone Cobblestone Multisize - 24"x24"

20MM THICKNESS
PORCELAIN PAVERS

04.1 BLUESTONE DESIGN PROJECT.

PROJECT

OUTDOOR FLOOR DESIGN
Frontier20 Thermal Bluestone Full Color - 12"x24"
Frontier20 Thermal Bluestone Full Color - 24"x24"

04.1 BLUESTONE DESIGN PROJECT. REDEFINE TRADITIONS.



Bluestone Design Project is a premium line inspired by the finest Pennsylvania native bluestone, widely used for prestigious projects all over North America.

A highly versatile outdoor collection with infinite combinations of colors, sizes, veneers, trim pieces and finishes, designed to meet the demands of Total Look outdoor project.

PROJECT

FLOOR DESIGN

Frontier20 Thermal Bluestone Full Color - 24"x48"
Frontier20 Full Color Bluestone Cobblestone Multisize - 24"x24"



PROJECT

OUTDOOR FLOOR DESIGN

Frontier20 Tumbled Bluestone - 9"x9"
Frontier20 Tumbled Bluestone - 8"x18"
Frontier20 Tumbled Bluestone Cobblestone Multisize - 24"x24"

WALL DESIGN

Vision Concrete - 24"x48"

04.1 **BLUESTONE DESIGN PROJECT.**
HIGH-TIER FINISH.

The **Bluestone Design Project** comes with the most refined and prestigious finishes available with the Pennsylvania stone.



THERMAL

The result of a high-grade flaming process, grants the tile its refined, rough textured surface.



NATURAL (CLEFT)

The traditional, natural split-stone finish, highlights the stone's uniquely layered structure.

TUMBLED

A prestigious finish that lends the surface its distinctive antiqued look, cherished for its rugged yet elegant nature.



04.1 **BLUESTONE DESIGN PROJECT.**

COLORS AND DESIGN.

The Bluestone Design Project explores the most exceptional and defining traits of the Pennsylvania native bluestone, such as the Blue Select color, known for its uniform and intense gray-blue shade, or the Full Color alternative, where polychromies and dynamic design meet to create an array of combinations.

Bluestone Design Project also revisits the prestigious Tumbled design, breathing new life into a historical pattern and the Cobblestone variant, enriched by infinite multicolored nuances.

As far as Porcelain Pavers, Bluestone Design Project offers an ample choice of customizable solutions, with options ranging from the standard 24"x24" size to 12"x24", 24"x36", 24"x48", 12"x48" and 12"x12". The antiqued Tumbled finish is available in the 9"x9" and 9"x18" versions, while the Cobblestone model comes in the traditional Cube pattern or in the unique Multisize variant.



TUMBLED BLUESTONE



TUMBLED BLUESTONE
COBBLESTONE CUBE



TUMBLED BLUESTONE
COBBLESTONE MULTISIZE



THERMAL BLUESTONE
BLUE SELECT



BLUESTONE BLUE SELECT

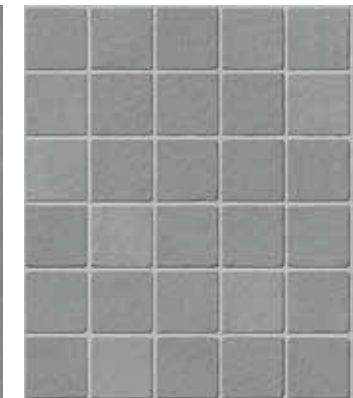

BLUE SELECT BLUESTONE
COBBLESTONE CUBE



BLUE SELECT BLUESTONE
COBBLESTONE MULTISIZE

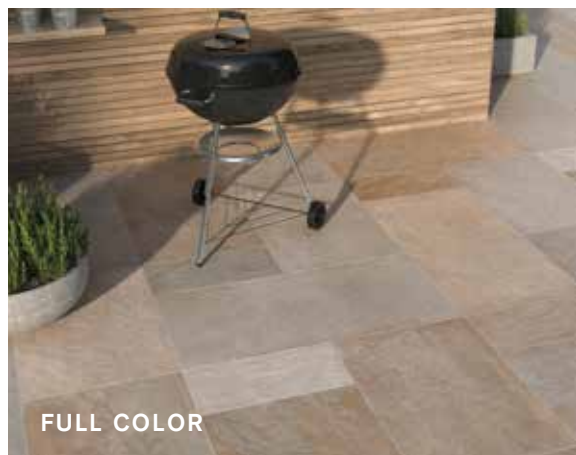

THERMAL BLUESTONE
FULL COLOR



BLUESTONE FULL COLOR



FULL COLOR BLUESTONE
COBBLESTONE CUBE



FULL COLOR BLUESTONE
COBBLESTONE MULTISIZE

04.1 **BLUESTONE DESIGN PROJECT.**

FLOOR AND WALL.

Bluestone Design Project presents an ample choice of boundless combinations not only for floor but also for wall application, thanks to the prestigious and decorative Porcelain Veneer range, available in two different versions: a refined and modern **Pro Ledgestone** and a more traditional **Quarry Ledgestone**.

A remarkable project with infinite combinations for your Bluestone Total Look Project.



PRO LEDGESTONE

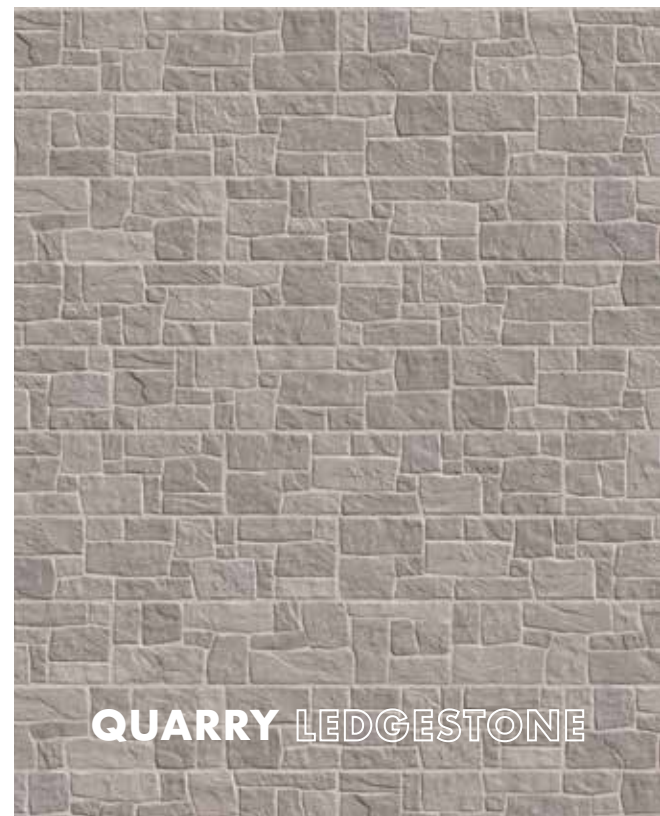

QUARRY LEDGESTONE



04.2 QUARTZITE DESIGN PROJECT.

PROJECT

OUTDOOR FLOOR DESIGN

- Frontier20 Arctic White - 24"x48"
- Frontier20 Arctic White - 12"x48"
- Frontier20 Arctic White - 24"x24"
- Frontier20 Arctic White - 12"x24"
- Frontier20 Arctic White - 12"x12"
- Frontier20 Arctic White Grip Stair Tread Rectified - 12"x24"
- Frontier20 Arctic White Riser Rectified - 8"x24"

OUTDOOR POOL DESIGN

- Frontier20 Arctic White Linear Cover Drain Set - 24"x11.63"
- Frontier20 Arctic White Coping Rectified - 12"x24"

WALL DESIGN

- Veneer World Pro LedgeStone Ridge Black - 6"x24"
- Veneer World Pro LedgeStone Bluestone Tumbled - 6"x24"
- Vision Concrete - 24"x48"
- Vision Concrete - 24"x24"
- Vision Concrete - 12"x24"

FLOWER BED WALL DESIGN

- Veneer World Pro LedgeStone Tumbled - 6"x24"

04.2 QUARTZITE DESIGN PROJECT.

A TRIBUTE TO ONE OF THE MOST AUTHENTIC AND ICONIC STONES.

_QDP, Quartzite Design Project, represents our tribute to the Quartzite natural stone. A stone deeply and widely used in architecture and now reinterpreted and proposed in porcelain, for 360° application whether in residential or commercial areas, for both indoor and outdoor, and for floors and walls.

_With its contemporary interpretation of the granular texture of the quartzite stone, Quartzite Design Project is ideal for outdoor spaces thanks to the Porcelain Pavers, Porcelain Veneers and Porcelain Grip Tiles offering. But exterior is not the only possible application. In fact, **QDP is perfect for indoor or In&Out transitional applications too**, thanks to the Porcelain Tiles offering, belonging to our Explore collection and available in 9mm thickness.

_Quartzite Design Project is a **stone effect with a strong character and chromatic richness** that celebrates all the beauty of this superior natural looking architectural stone.



PROJECT

FLOOR DESIGN

- Frontier20 African Beige - 24"x48"
- Frontier20 African Beige - 12"x48"
- Frontier20 African Beige - 24"x24"
- Frontier20 African Beige - 12"x24"
- Frontier20 African Beige Stair Tread - 12"x24"
- Frontier20 Soul Walnut - 12"x48"

04.2 **QUARTZITE DESIGN PROJECT.**

THE QUARTZITE WORLD IN YOUR HAND.

ARCTIC WHITE
24"x48" - 12"x48" - 24"x36" - 24"x24" - 12"x24" - 12"x12"

AFRICAN BEIGE
24"x48" - 12"x48" - 24"x36" - 24"x24" - 12"x24" - 12"x12"

STAR GREY
24"x48" - 12"x48" - 24"x36" - 24"x24" - 12"x24" - 12"x12"

The Quartzite Design Project offers endless possibilities to every project, thanks to its broad selection of surfaces, sizes and thicknesses. The project is composed and designed to fit every surface with unquestionable appeal, and embraces 4 different product categories: Porcelain Pavers, Porcelain Veneers, Porcelain Grip Tiles and Porcelain Tiles.

PORCELAIN PAVERS

3 colors, available in 20mm thickness within Frontier20 range, ideal for 360° outdoor applications with outstanding technical performances and a wide size offering, from 12"x12" to 24"x48".

PROJECT

FLOOR DESIGN

Frontier20 Star Grey - 24"x48"
Frontier20 Star Grey - 12"x48"
Frontier20 Star Grey - 24"x24"
Frontier20 Star Grey - 12"x24"

FIRE PIT DESIGN

Frontier20 Star Grey - 12"x48"



04.2 **QUARTZITE DESIGN PROJECT.**

URBAN
LEDGESTONE

PORCELAIN
VENEERS

4 color proposal to decorate every wall both indoor or outdoor with the same authentic and rich look of the best natural quartzite stones, by blending the tradition of the veneers, a modern Urban Ledgestone shape and the remarkable performance of porcelain.

_Urban is the Porcelain Veneer proposal for whoever is looking for a clean, neat and modern design.

Made of listels regular and uniform in height, characterized by a smooth and refined surface finish, Urban is intended for wall compositions to fit any contemporary architectural environments where the tradition of stone veneers meets the elegance of a clean look.

Each veneer is composed by the assembling of same size pieces with a 3D relief to create vibrant and new decorative wall surfaces.

URBAN LEDGESTONE
ARCTIC WHITE

URBAN LEDGESTONE
AFRICAN BEIGE

URBAN LEDGESTONE
STAR GREY

URBAN LEDGESTONE
VOLCANIC BLACK



PROJECT
OUTDOOR FLOOR DESIGN
Frontier20 Michelangelo Extra White - 24"x48"
Frontier20 Michelangelo Extra White Riser - 6"x48"
WALL DESIGN
Veneer World Urban Ledgestone Explore Volcanic Black - 6"x24"

04.2 QUARTZITE DESIGN PROJECT.

GRIP TILES

COLORED BODY PORCELAIN GRIP TILES

PORCELAIN GRIP TILES - 9mm thickness

Rectified Monocaliber

4 colors offered in 9mm thickness that fit every outdoor installation over concrete or indoor application, wherever an outstanding slip resistance is needed.

EXPLORE ARCTIC WHITE GRIP



Available size



12"x24"

± 0.35"
± 9mm



V2

EXPLORE AFRICAN BEIGE GRIP



Available size



12"x24"

± 0.35"
± 9mm



V2

EXPLORE STAR GREY GRIP



Available size



12"x24"

± 0.35"
± 9mm



V2

EXPLORE EVEREST DARK GRIP



Available size



12"x24"

± 0.35"
± 9mm



V2

04.2 QUARTZITE DESIGN PROJECT.













COORDINATED PORCELAIN TILES

FOR IN&OUT APPLICATIONS AND OUTDOOR WALLS

PORCELAIN TILES - 9mm thickness

Rectified Monocaliber

5 colors in 9mm colored body porcelain, all rectified and monocaliber, ranging from 12"x24" to 24"x48" size, to complete your project by transitioning the same quartzite look either on outdoor walls and facades or in indoor application, residential as well as commercial, for both floors and walls.

						
		Explore Arctic White	Explore African Beige	Explore Star Grey	Explore Everest Dark	Explore Volcanic Black
	24"x48" MATT ± 0.35" / 9 mm	•	•	•		
	24"x24" MATT ± 0.35"	•	•	•	•	•
	12"x24" MATT ± 0.35"	•	•	•	•	•
	12"x12" MOSAIC A ± 0.35"	•	•	•	•	•
	12"x10" MOSAIC D ± 0.35"	•	•	•	•	•
	3"x24" BULLNOSE	•	•	•	•	•
	6"x12" COVE BASE	•	•	•	•	•

04.3 TRAVERTINE CROSS CUT DESIGN PROJECT.

PROJECT

OUTDOOR FLOOR DESIGN

- Frontier20 Travertine Cross Cut Cream - 24"x48"
- Frontier20 Travertine Cross Cut Cream - 12"x48"
- Frontier20 Travertine Cross Cut Cream - 24"x24"
- Frontier20 Travertine Cross Cut Cream - 12"x24"
- Frontier20 Travertine Cross Cut Cream - 12"x12"
- Frontier20 Travertine Cross Cut Cream Stair Tread - 12"x48"
- Frontier20 Travertine Cross Cut Cream Riser - 6"x48"

WALL DESIGN

- Frontier20 Travertine Cross Cut Cream - 12"x48"
- Vision Dove - 24"x48"

04.3 TRAVERTINE CROSS CUT DESIGN PROJECT.

MEET THE AMERICAN LOOK.

Travertine Cross Cut Design Project is Landmark's tribute to this iconic stone. The project proposes the modern porcelain pavers-based reinterpretation of Cross Cut Travertine, a natural travertine framed by a lengthy sedimentation process, characterized by typical directional veins running all across the stone blocks, that, according to the name of the stone, is "cross cut" (cut against the veins).

Available in a broad range of sizes and 4 different colorations to be inspired from, Travertine Cross Cut Design Project combines the elegant cross-cut look of the referenced natural stone, simple and always different from piece to piece with all superior performance of the best porcelain stoneware, in terms of the strength, resistance, easy maintenance and durability.

PROJECT

OUTDOOR FLOOR DESIGN

Frontier20 Travertine Cross Cut Silver - 24"x48"

Frontier20 Travertine Cross Cut Silver - 12"x48"

Frontier20 Travertine Cross Cut Silver - 24"x24"

Frontier20 Travertine Cross Cut Silver - 12"x24"

Frontier20 Travertine Cross Cut Silver Stair Tread - 12"x48"

Frontier20 Travertine Cross Cut Silver Riser - 6"x48"

WALL DESIGN

Brick World Soho Black - 3"x12"

Frontier20 Travertine Cross Cut Silver - 24"x48"

INDOOR FLOOR DESIGN

Spirit Old Maple - 8"x40"



04.3 TRAVERTINE CROSS CUT DESIGN PROJECT.

**A WIDE RANGE OF SIZES
FOR MULTIPLE PATTERNS.**

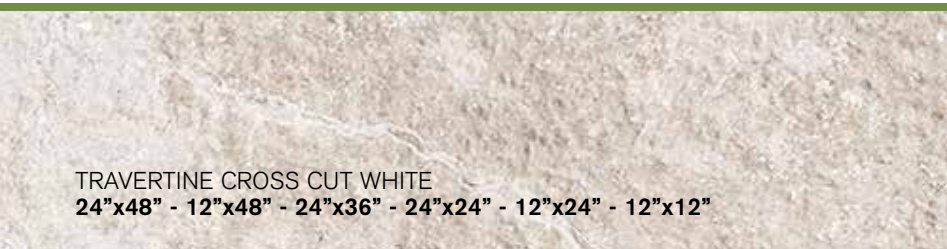

TRAVERTINE CROSS CUT WHITE
24"x48" - 12"x48" - 24"x36" - 24"x24" - 12"x24" - 12"x12"



TRAVERTINE CROSS CUT SILVER
24"x48" - 12"x48" - 24"x36" - 24"x24" - 12"x24" - 12"x12"

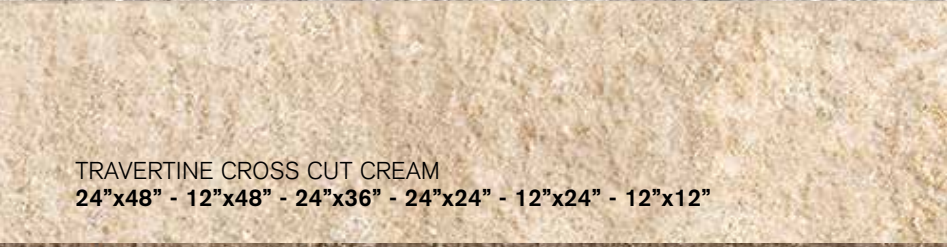

TRAVERTINE CROSS CUT CREAM
24"x48" - 12"x48" - 24"x36" - 24"x24" - 12"x24" - 12"x12"



TRAVERTINE CROSS CUT NOCE
24"x24"

Thanks to its new broad selection of sizes, ranging from traditional 12"x12" to the large size 24"x48", Travertine Cross Cut Design Project allows a variety of single and multi-size laying patterns to meet every design need.

Plus, the performance of the Porcelain Pavers guarantees the highest standards of safety, resistance and durability.



PROJECT

OUTDOOR FLOOR DESIGN

- Frontier20 Travertine Cross Cut White - 24"x48"
- Frontier20 Travertine Cross Cut White - 24"x24"
- Frontier20 Travertine Cross Cut White - 12"x24"
- Frontier20 Travertine Cross Cut White - 12"x12"
- Frontier20 Travertine Cross Cut White Grip Stair Tread - 12"x24"
- Frontier20 Travertine Cross Cut White Riser - 8"x24"

FLOWER BEDS

- Frontier20 Travertine Cross Cut White - 24"x48"

04.4 INDIANA SALEM DESIGN PROJECT.

NEW
2023

PROJECT

OUTDOOR FLOOR DESIGN

Frontier20 Indiana Variegated - 24"x24"

Frontier20 Indiana Variegated - 12"x24"

Frontier20 Essence Brown - 12"x48"

WALL DESIGN

Veneer World Atelier Dynamic Indiana Buff Select - 12"x24"

FIREPIT WALL DESIGN

Veneer World Atelier Dynamic Indiana Buff Select - 12"x24"

FLOWER BED WALL DESIGN

Frontier20 Indiana Variegated - 24"x24"

04.4 **INDIANA SALEM DESIGN PROJECT.**

THE UTMOST ICON OF AMERICAN ARCHITECTURE

Indiana Salem Design Project is Landmark's porcelain interpretation of Indiana Limestone, a natural stone also known as Salem stone and commonly found in Indiana. As with every freestone, it shows no splitting or direction in its highest select grade version.

The aesthetic natural characteristics of Indiana Limestone is now combined with higher performances of resistance and durability of the best porcelain material. This refined and graceful natural material has been used for many American buildings and can be considered an icon of modern and postmodern American architecture.



PROJECT

OUTDOOR FLOOR DESIGN

Frontier20 Indiana Buff Select - 24"x48"

WALL DESIGN

Veneer World Atelier Groove S Indiana Buff Select - 12"x24"

FIREPIT / FLOWER BED WALL DESIGN

Veneer World Atelier Groove S Indiana Buff Select - 12"x24"

04.4 INDIANA SALEM DESIGN PROJECT.

COLORS AND FINISHES

With **Indiana Salem**, Landmark reproduces the timeless beauty and the evergreen style of Indiana limestone in multiple colors and different finishes: from refined and non-slip surfaces ideal for any outdoor setting to tooled finishes, perfect for stunning and decorative wall applications.

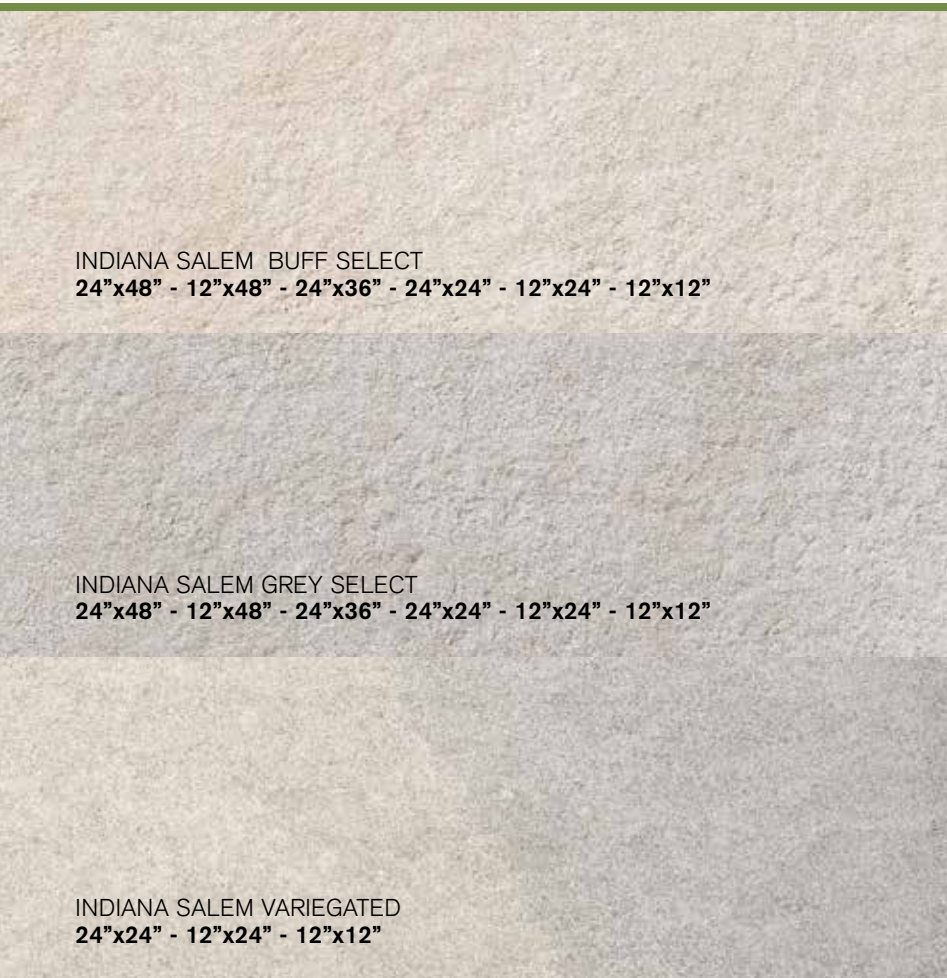

INDIANA SALEM BUFF SELECT
24"x48" - 12"x48" - 24"x36" - 24"x24" - 12"x24" - 12"x12"

INDIANA SALEM GREY SELECT
24"x48" - 12"x48" - 24"x36" - 24"x24" - 12"x24" - 12"x12"

INDIANA SALEM VARIEGATED
24"x24" - 12"x24" - 12"x12"

PORCELAIN PAVERS

Buff Select

Warm and light creamy color with brownish reflexes on a very fine and refined grainy surface.

Grey Select

Same refined grainy surface, characterized by ecru hue with light grey to bluish shades.

Variegated

While the degree of texture can vary from a fine- to a coarse-grain, this color includes a significative variation from piece to piece, alternating pieces that are full grey or full buff with more variegated ones, that include both grey and buff colors within the same piece.

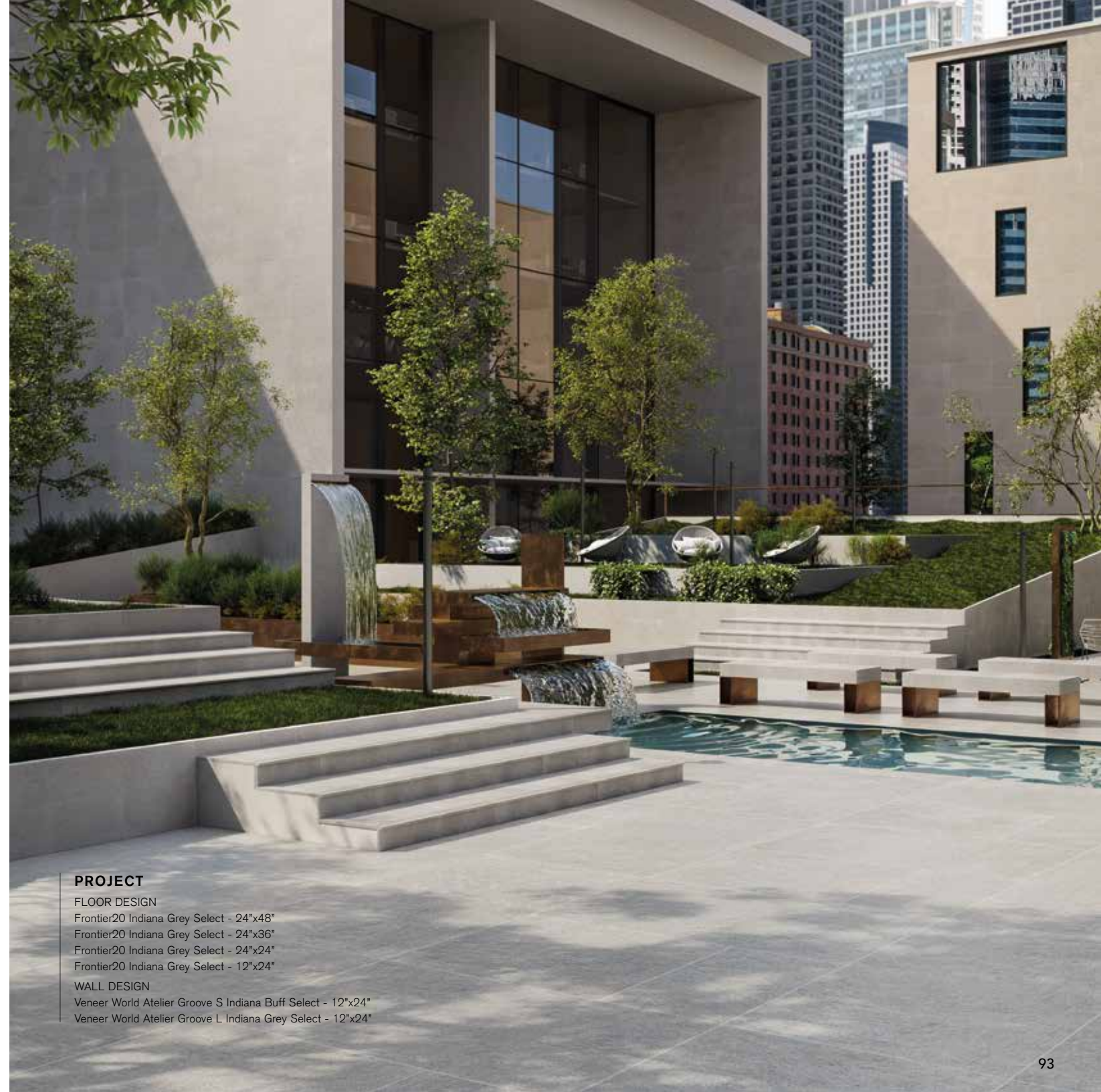

PROJECT

FLOOR DESIGN

- Frontier20 Indiana Grey Select - 24"x48"
- Frontier20 Indiana Grey Select - 24"x36"
- Frontier20 Indiana Grey Select - 24"x24"
- Frontier20 Indiana Grey Select - 12"x24"

WALL DESIGN

- Veneer World Atelier Groove S Indiana Buff Select - 12"x24"
- Veneer World Atelier Groove L Indiana Grey Select - 12"x24"

04.4 INDIANA SALEM DESIGN PROJECT.

ATELIER

Porcelain Veneers Atelier: The collection is also enriched with three tooled finishes suited for walls (both indoor and outdoor) and available in Buff and Grey colors:

Atelier Groove S: scratched finish that blends the elegance of natural stone with a 3D surface effect. The brushed and hammered embossed texture creates special plays of light and shadow, along with surface scratches, enhancing the decorative added value of the product.

Atelier Groove L: same scratched finish as Groove S, but with a larger gap among scratches, that elevates natural inspiration through an innovative technology to create a simple and elegant decoration.

Atelier Dynamic: elaborated finish with multiple geometries on the surface, able to offer a contemporary solution that reserves the natural touch of the stone, characterized by micro lines running along the undulating dunes of the surface.

These finishes will make your project stand out by adding a special touch and decorative spirit to vertical installations such as walls and facades.

ATELIER
GROOVE S



ATELIER
GROOVE L



ATELIER
DYNAMIC



PROJECT

OUTDOOR FLOOR DESIGN
Frontier20 Artistic Beige - 24"x24"
WALL DESIGN
Veneer World Atelier Groove L Indiana Buff Select - 12"x24"
Veneer World Atelier Groove S Indiana Grey Select - 12"x24"

20MM THICKNESS
PORCELAIN PAVERS

05
DESIGN WORK
PROJECT.



05 DESIGN WORK PROJECT.

THE ULTIMATE DESIGNER TOOL.

Perfect continuity. Design Work is a major project composed of 6 porcelain tile collections in standard thickness, two 20mm Porcelain Pavers looks, Mosaics and Porcelain Veneers. A tool to design freely unique spaces.

The 20mm proposal of Design Work is composed of two different looks in 20mm: a Minimal Stone and a Terrazzo look, for outdoor application further enriched by 3 Frontier20 - Deco proposals and with matching porcelain tiles of the Elite and Masterplan collection for a seamless look transition.

In addition to that the minimal look, stone and Masterplan collection matches with 3 multicolor porcelain veneer for decorative wall application.

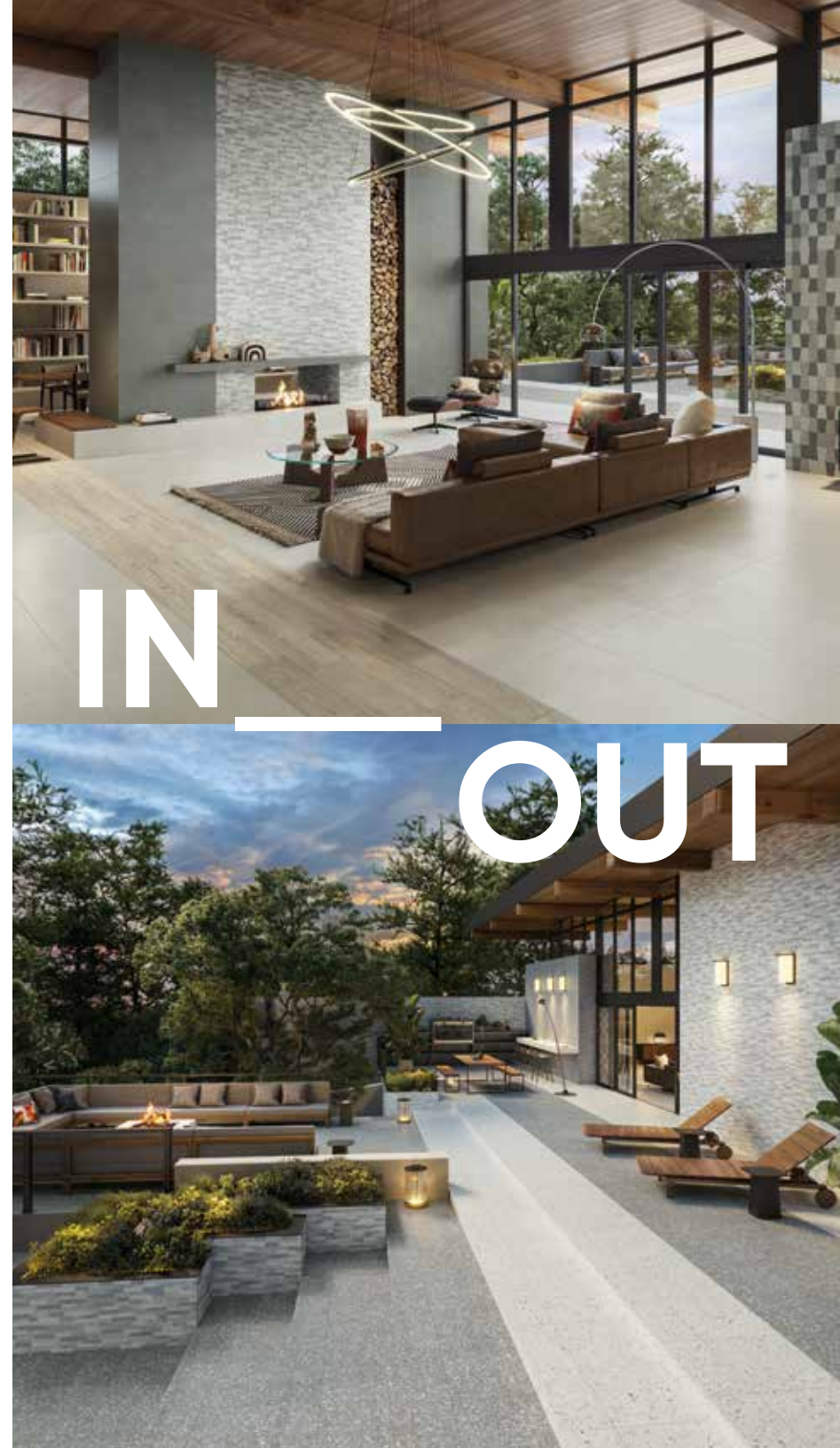

PROJECT WITHOUT LIMITS.

Design Work is the ultimate tool to successfully face all designer's challenges. A complete surface system made to combine and mix contemporary looks such as Minimal Stone and Terrazzo look in 20mm along with Porcelain Veneers and Grip Tiles in 9mm. All of those options can also be integrated with indoor 9mm Landmark collection such as Masterplan, Elite, Vision, Vision color, Feeling and Soul for a total porcelain project with no limit to creativity.



05 DESIGN WORK PROJECT.

REFINED SOLUTIONS FOR OUTDOOR LIFE.

Frontier20 Porcelain Pavers are a perfect solution for landscaping outdoor spaces. The high performance guarantees superior performance: stain-resistant, anti-slip, chemical resistant, maintenance-free product has led to the development of a revolutionary aesthetically superior product, versatile enough for outdoors as well as indoors.



DIAMOND WHITE
24"x24"

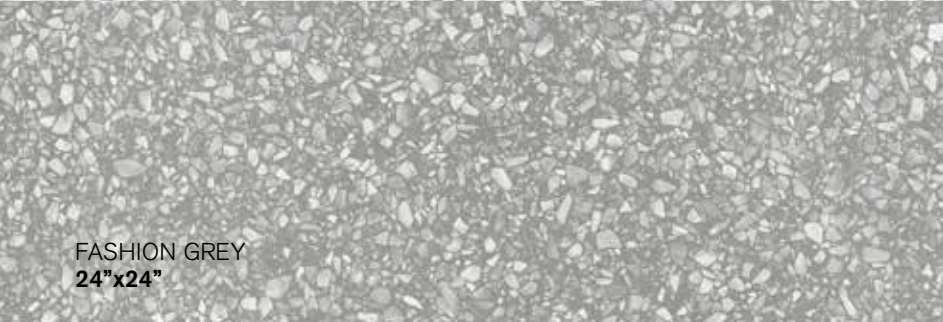

FASHION GREY
24"x24"

PORCELAIN PAVERS

Porcelain Paver surfaces available in two neutral colors combine refined aesthetics with superior performance. Thanks to their square sizes of 24x24" with a thickness of 20 mm, they allow high versatility in outdoor spaces.



ARTISTIC BEIGE
24"x24" - 12"x24"

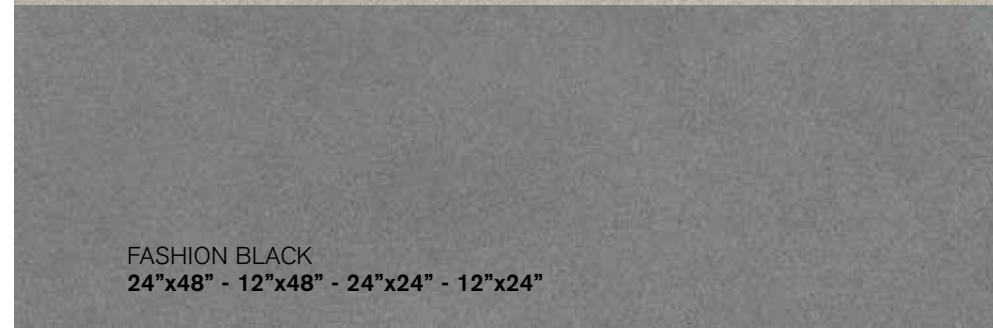

FASHION BLACK
24"x48" - 12"x48" - 24"x24" - 12"x24"

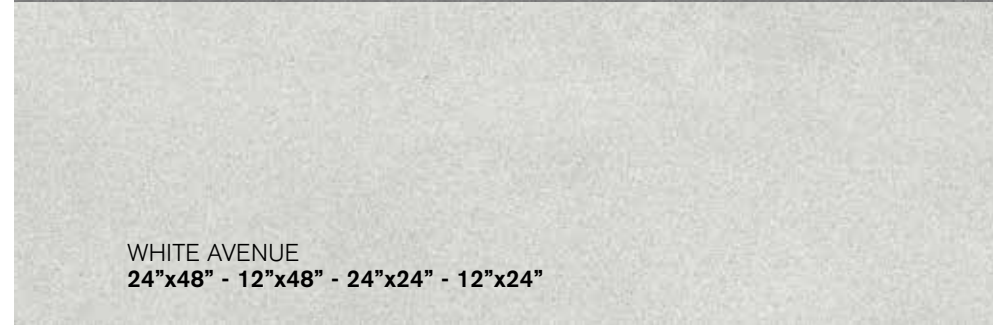

WHITE AVENUE
24"x48" - 12"x48" - 24"x24" - 12"x24"

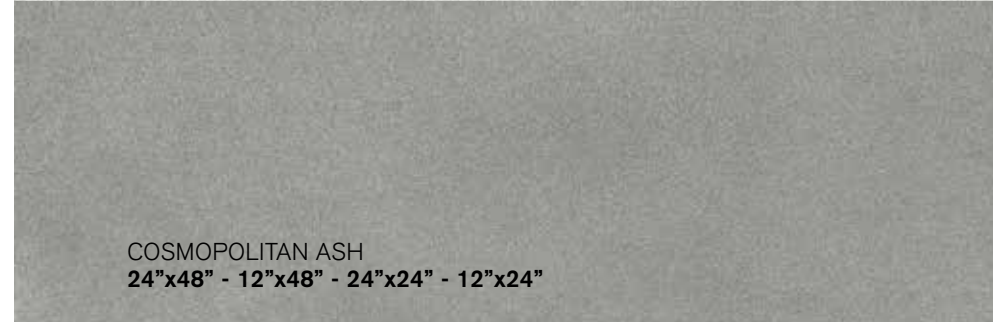

COSMOPOLITAN ASH
24"x48" - 12"x48" - 24"x24" - 12"x24"

PORCELAIN PAVERS

The Minimal Stone look is available in 4 modular sizes and 4 different contemporary colors. It can be combined with all the surfaces of the Frontier20 range, giving life to always original outdoor environments.

05 DESIGN WORK PROJECT.

URBAN LEDGESTONE

PORCELAIN VENEERS

3 color offers meet all aesthetic needs and allows you to decorate the walls with a look in line with the latest trends in architecture and interior design. With the Porcelain Veneers Urban Ledgestone, tradition meets contemporary opening new frontiers in the design of outdoor spaces.

Urban Ledgestone is Porcelain Veneer made with listels of the same height, laid horizontally to design an elegant geometric pattern.

Inspired by natural quartzite stones, the surface reproduces the water saw cut used with real stone veneers, ensuring an authentic look. Each veneer is made by assembling pieces of the same size with a 3D relief that gives dynamism to the entire wall.

URBAN LEDGESTONE
WHITE MIX

URBAN LEDGESTONE
BEIGE MIX

URBAN LEDGESTONE
ASH MIX

PROJECT
WALL DESIGN
Veneer World Urban Ledgestone Ash Mix - 6"x24"

05 DESIGN WORK PROJECT.

GRIP TILES

COLORED BODY PORCELAIN GRIP TILES

PORCELAIN GRIP TILES - 9mm thickness

Rectified Monocaliber

Grip Tiles guarantee the highest level of safety. Thanks to the non-slip finish they are the ideal solution for residential and commercial spaces where high safety standards are required.

MASTERPLAN WHITE AVENUE GRIP

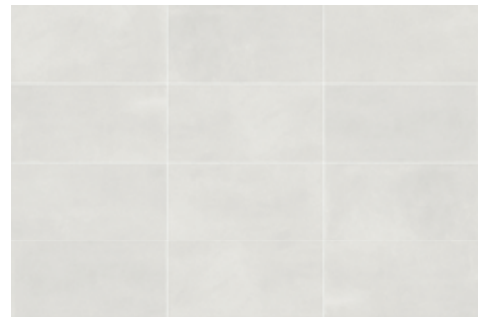

Available size
 0.35"
 9mm
 12"x24"

 V2

MASTERPLAN PRECIOUS IVORY GRIP

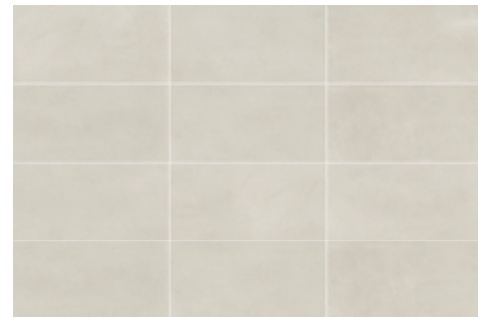

Available size
 0.35"
 9mm
 12"x24"

 V2

MASTERPLAN COSMOPOLITAN ASH GRIP

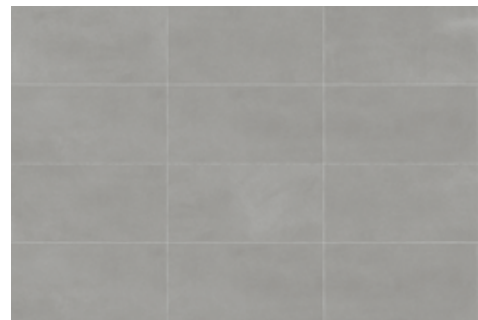

Available size
 0.35"
 9mm
 12"x24"

 V2

MASTERPLAN METRO GREY GRIP

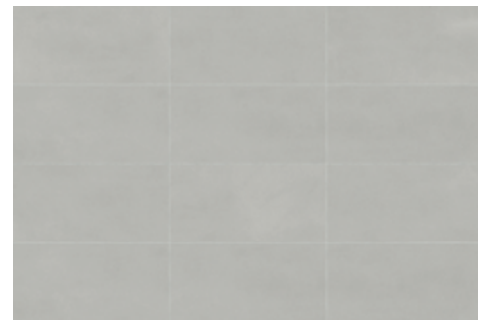

Available size
 0.35"
 9mm
 12"x24"

 V2



PROJECT

- FLOOR DESIGN
- Masterplan Precious Ivory - 24"x48"
- Masterplan Precious Ivory Grip - 12"x24"
- Masterplan Artistic Beige Mosaic A - 12"x12"
- Feeling Honey - 8"x40"
- WALL DESIGN
- Masterplan Artistic Beige Mosaic A - 12"x12"
- Feeling Honey - 8"x40"



05 DESIGN WORK PROJECT.















COORDINATED PORCELAIN TILES

PORCELAIN TILES - 9mm thickness

FOR IN&OUT APPLICATIONS AND OUTDOOR WALLS

Rectified Monocaliber

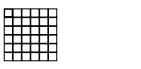
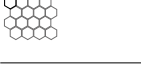
A wide range of sizes available in many neutral colors allows total freedom. The different surfaces can be combined with each other to design external walls and create in & out stylistic and chromatic continuity.







										
	Masterplan White Avenue	Masterplan Precious Ivory	Masterplan Artistic Beige	Masterplan Cosm. Ash	Masterplan Metro Grey	Masterplan Fashion Black	Elite Diamond White	Elite Oyster Beige	Elite Fashion Grey	Elite Precious Black
 24"x48" MATT ± 0.35/9 mm	•	•		•						
 24"x24" MATT ± 0.35"	•	•	•	•	•	•	•	•	•	•
 12"x24" MATT ± 0.35"	•	•	•	•	•	•	•	•	•	•
 12"x12" MOSAIC A ± 0.35"	•	•	•	•	•	•				
 12"x10" MOSAIC D ± 0.35"		•			•					
 13.7"x12" MOSAIC G ± 0.35"		•			•					



05 DESIGN WORK PROJECT.









COORDINATED BULLNOSE AND COVE BASE

FROM VISION, VISION COLOR AND MASTERPLAN COLLECTIONS

				
	Elite Diamond White	Elite Oyster Beige	Elite Fashion Grey	Elite Precious Black
 3"x24" BULLNOSE	Vision Dove Vision Color Star White Masterplan White Avenue	Vision Dove Vision Color Star White Masterplan Precious Ivory Masterplan White Avenue	Vision Concrete Vision Color Star White Masterplan Cosmopolitan Ash	Vision Concrete Vision Dark Vision Color Star White Vision Color Star Black Masterplan Fashion Black
 6"x12" COVE BASE	Vision Dove Vision Color Star White	Vision Dove Vision Color Star White	Vision Concrete Vision Color Star White	Vision Concrete Vision Dark Vision Color Star White Vision Color Star Black

COORDINATED BULLNOSE AND COVE BASE

FROM VISION AND VISION COLOR COLLECTIONS

						
	Masterplan White Avenue	Masterplan Precious Ivory	Masterplan Artistic Beige	Masterplan Cosm. Ash	Masterplan Metro Grey	Masterplan Fashion Black
 3"x24" BULLNOSE	•	•	•	•	•	•
 6"x12" COVE BASE	Vision Concrete Vision Color Star White	Vision Dove Vision Color Star White Vision Dove Vision Color Star White	Vision Dove Vision Color Star White	Vision Concrete Vision Color Star White Vision Concrete Vision Color Star White	Vision Concrete Vision Color Star White	Vision Concrete Vision Color Star White Vision Color Star Black

20MM THICKNESS
PORCELAIN PAVERS

06
FRONTIER20 - DECO.



PROJECT

OUTDOOR FLOOR DESIGN

Frontier20 Diamond White - 24"x24"

Frontier20 Patchwork Ash - 24"x24"

OUTDOOR WALL DESIGN

Veneer World Urban Ledgestone White Mix - 6"x24"

POOL DESIGN

Frontier20 Fashion Grey - 24"x24"

06 FRONTIER20 - DECO.

GEOMETRIC DECORATIONS.

Frontier20 offers a fashionable solution for floor decoration: Patchwork combines different geometric shapes into a new pattern to create an original eye-catching composition in outdoor spaces. A range of contemporary Porcelain Pavers that carry the ultimate trends in architecture and landscaping design.

The high quality of Landmark porcelain guarantees high performance in any context. Patchwork resists thermal shocks, scratches, bumps, and maintains its colors unchanged over time. Thanks to its extreme versatility, it guarantees a decorative solution that can be combined with all the surfaces of the F20 range, to give an outstanding look to any outdoor space, such as balcony or terrace.

PROJECT

OUTDOOR FLOOR DESIGN
Frontier20 Patchwork Mix - 24"x24"
WALL DESIGN
Masterplan Precious Ivory - 24"x48'





06 FRONTIER20 - DECO.

NEUTRAL MATCHING COLORS.

Patchwork is available in 3 different light patterns enriched with neutral contrasting shades that can be combined with each other, increasing design freedom. The modular size 24"x24" allows multi-laying patterns to meet every need.



FRONTIER20 DECO PATCHWORK WHITE
24"x24"

FRONTIER20 DECO PATCHWORK ASH
24"x24"

FRONTIER20 DECO PATCHWORK MIX
24"x24"

MATCHES WITH

White Avenue	Precious Ivory	Artistic Beige
--------------	----------------	----------------

MATCHES WITH

Metro Grey	Fashion Black	Cosm. Ash
------------	---------------	-----------

MATCHES WITH

White Avenue	Artistic Beige	Cosm. Ash	Fashion Black
--------------	----------------	-----------	---------------



PROJECT
 OUTDOOR FLOOR DESIGN
 Frontier20 Fashion Grey - 24"x24"
 Frontier20 Patchwork White - 24"x24"
 OUTDOOR WALL DESIGN
 Veneer World Urban LedgeStone Ash Mix - 6"x24"
 COUNTER AND BENCHES
 Frontier20 Diamond White - 24"x24"

M.P.D.

MULTI PATTERN DESIGN

The **Multi Pattern Design** (M.P.D.) is a project designed to allow combination of multiple size patterns and therefore develop creative and original outdoor design solutions. M.P.D. project is available in three different versions:

- **M.P.D. Big:** allows multiple big size patterns made by using 6 formats (24"x48", 12"x48", 24"x36", 24"x24", 12"x24", 12"x12").
- **M.P.D. Small:** combines 12"x12", 12"x24" and 24"x24" formats to create smaller size patterns.
- **M.P.D. Mini:** combines 9"x9" and 9"x18" to create refined and precious patterns.

PROJECT

OUTDOOR FLOOR DESIGN

Frontier20 Star Grey - 24"x48"

Frontier20 Star Grey - 12"x48"

Frontier20 Star Grey - 24"x24"

Frontier20 Star Grey - 12"x24"

Frontier20 Star Grey - 12"x12"

Frontier20 Arctic White - 12"x48"

M.P.D. BIG ONE*



M.P.D. BIG TWO*



Module percentage

24"x48" = 40%
24"x24" = 20%
24"x36" + 12"x24" (MIX) = 40% **

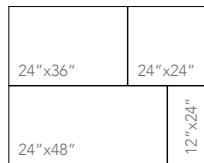

Available colors

- Bluestone Blue Select
- Bluestone Full color
- Flagstone Pink-Tan
- Travertine Cross Cut White
- Travertine Cross Cut Cream
- Travertine Cross Cut Silver
- Limestone
- Michelangelo Extra White
- Arctic White
- African Beige
- Star Grey
- Indiana Buff Select
- Indiana Grey Select

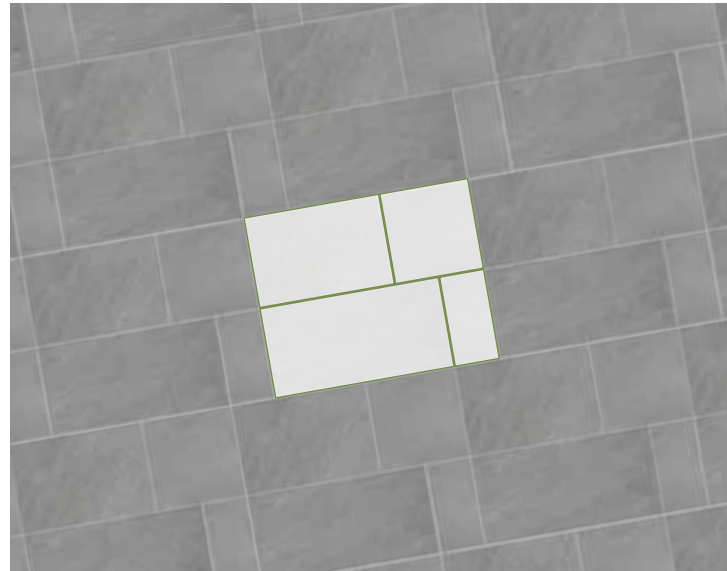

* Modular products with 6 mm joint (approx 1/4").
** NOTE: The 24"x36" and 12"x24" sizes (MIX) are palletized together on the same single pallet containing the correct percentages of each size.

Module percentage

24"x48" = 50%
24"x36" + 12"x24" (MIX) = 50% **

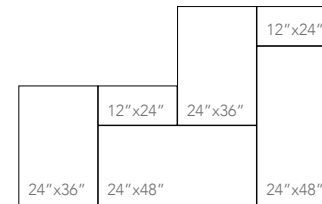

Available colors

- Bluestone Blue Select
- Bluestone Full color
- Flagstone Pink-Tan
- Travertine Cross Cut White
- Travertine Cross Cut Cream
- Travertine Cross Cut Silver
- Limestone
- Michelangelo Extra White
- Arctic White
- African Beige
- Star Grey
- Indiana Buff Select
- Indiana Grey Select



* Modular products with 6 mm joint (approx 1/4").
** NOTE: The 24"x36" and 12"x24" sizes (MIX) are palletized together on the same single pallet containing the correct percentages of each size.

M.P.D. BIG THREE*



Module percentage

24"x48" = 40%
24"x24" = 20%
24"x36" + 12"x24" (MIX) = 40% **

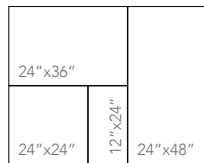

Available colors

- Bluestone Blue Select
- Bluestone Full color
- Flagstone Pink-Tan
- Travertine Cross Cut White
- Travertine Cross Cut Cream
- Travertine Cross Cut Silver
- Limestone
- Michelangelo Extra White
- Arctic White
- African Beige
- Star Grey
- Indiana Buff Select
- Indiana Grey Select



* Modular products with 6 mm joint (approx 1/4").

** NOTE: The 24"x36" and 12"x24" sizes (MIX) are palletized together on the same single pallet containing the correct percentages of each size.

M.P.D. BIG FOUR*



Module percentage

24"x48" = 28.6%
24"x24" = 14.3%
24"x36" + 12"x24" (MIX) = 57.1% **

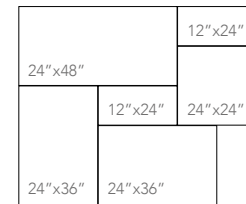

Available colors

- Bluestone Blue Select
- Bluestone Full color
- Flagstone Pink-Tan
- Travertine Cross Cut White
- Travertine Cross Cut Cream
- Travertine Cross Cut Silver
- Limestone
- Michelangelo Extra White
- Arctic White
- African Beige
- Star Grey
- Indiana Buff Select
- Indiana Grey Select



* Modular products with 6 mm joint (approx 1/4").

** NOTE: The 24"x36" and 12"x24" sizes (MIX) are palletized together on the same single pallet containing the correct percentages of each size.

M.P.D. BIG FIVE*

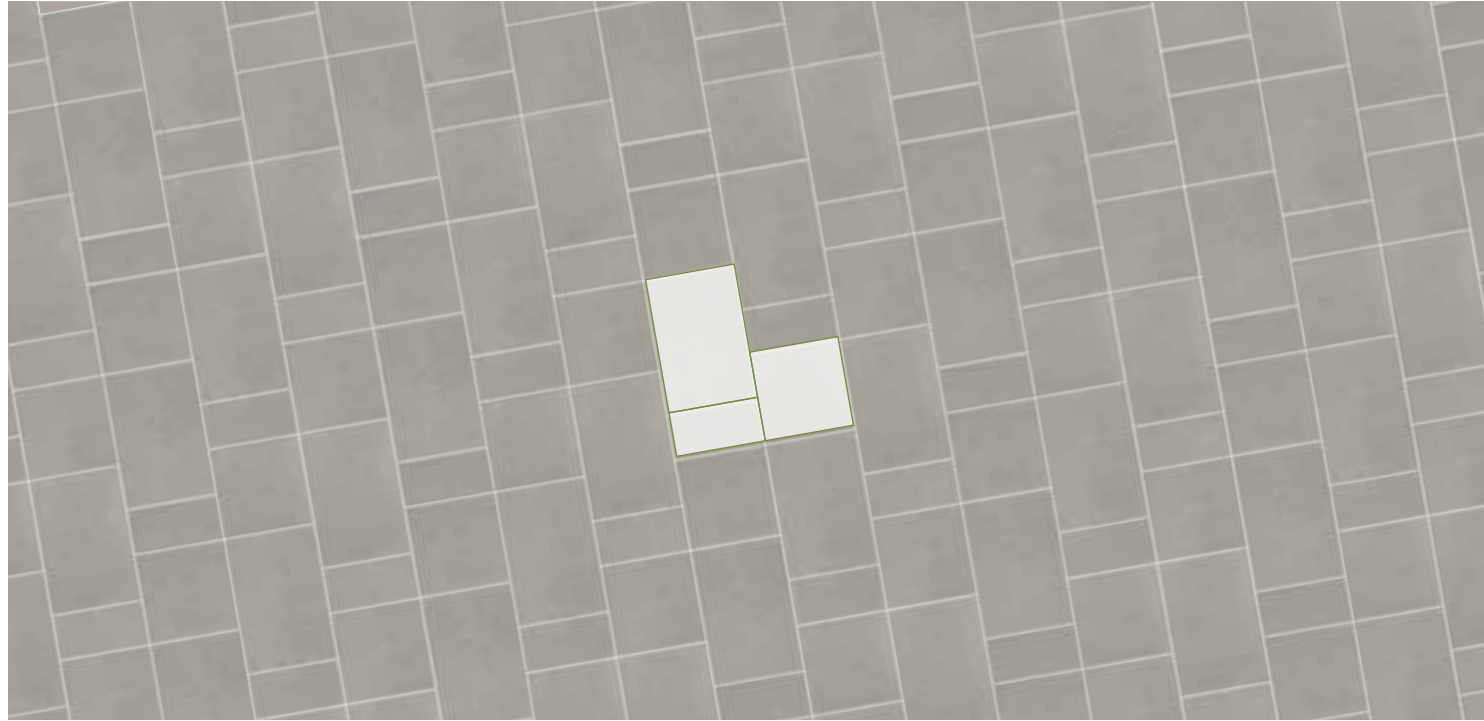

M.P.D. BIG SIX*

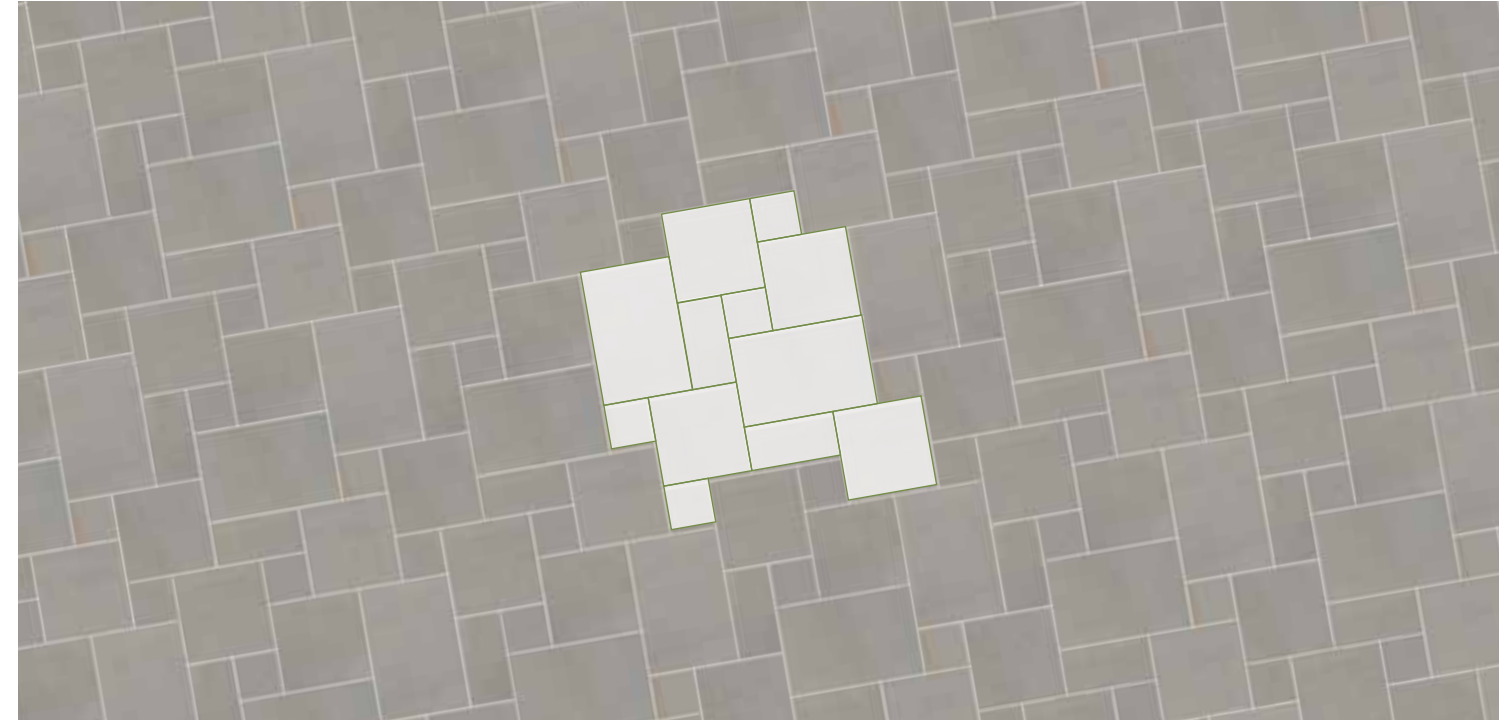

Module percentage

% HP1
 24"x24" = 33%
 24"x36" + 12"x24" (MIX) = 67% **

% HP2
 24"x36" = 50%
 24"x24" = 33%
 12"x24" = 17%

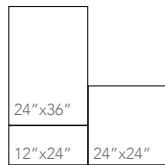

Available colors HP1

- Bluestone Blue Select
- Bluestone Full color
- Flagstone Pink-Tan
- Travertine Cross Cut White
- Travertine Cross Cut Cream
- Travertine Cross Cut Silver
- Limestone
- Michelangelo Extra White
- Arctic White
- African Beige
- Star Grey
- Indiana Buff Select
- Indiana Grey Select

Available colors HP2

- Thermal Bluestone Blue Select
- Thermal Bluestone Full Color

Module percentage

% HP1
 24"x24" = 45%
 12"x12" = 11%
 24"x36" + 12"x24" (MIX) = 44% **

% HP2
 24"x36" = 33%
 24"x24" = 45%
 12"x24" = 11%
 12"x12" = 11%

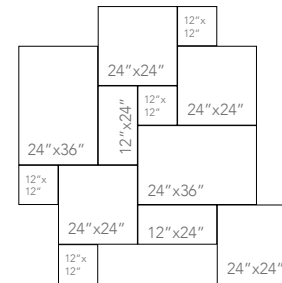

Available colors HP1

- Bluestone Blue Select
- Bluestone Full color
- Flagstone Pink-Tan
- Travertine Cross Cut White
- Travertine Cross Cut Cream
- Travertine Cross Cut Silver
- Limestone
- Michelangelo Extra White
- Arctic White
- African Beige
- Star Grey
- Indiana Buff Select
- Indiana Grey Select

Available colors HP2

- Thermal Bluestone Blue Select
- Thermal Bluestone Full Color

* Modular products with 6 mm joint (approx 1/4").
 ** NOTE: The 24"x36" and 12"x24" sizes (MIX) are palletized together on the same single pallet containing the correct percentages of each size.

* Modular products with 6 mm joint (approx 1/4").
 ** NOTE: The 24"x36" and 12"x24" sizes (MIX) are palletized together on the same single pallet containing the correct percentages of each size.

M.P.D. BIG SEVEN*

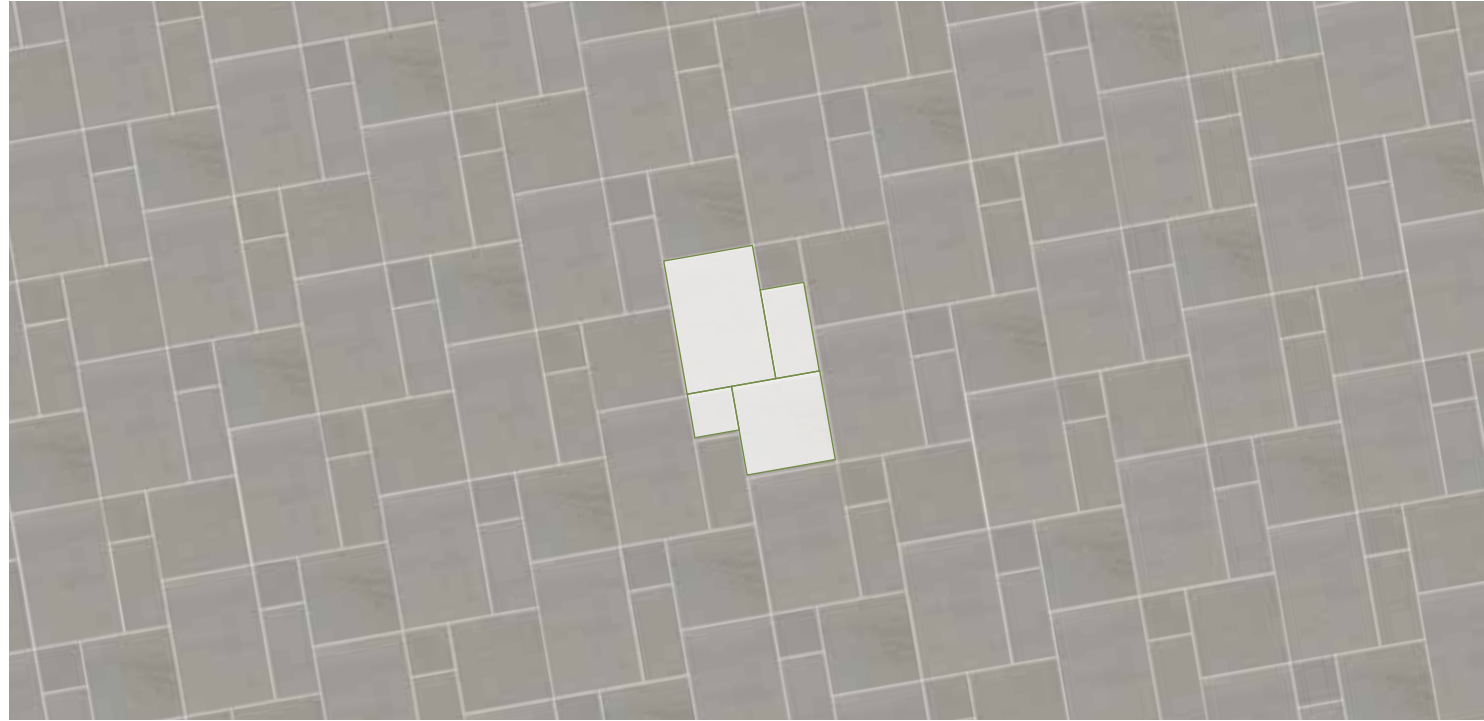

M.P.D. BIG EIGHT*

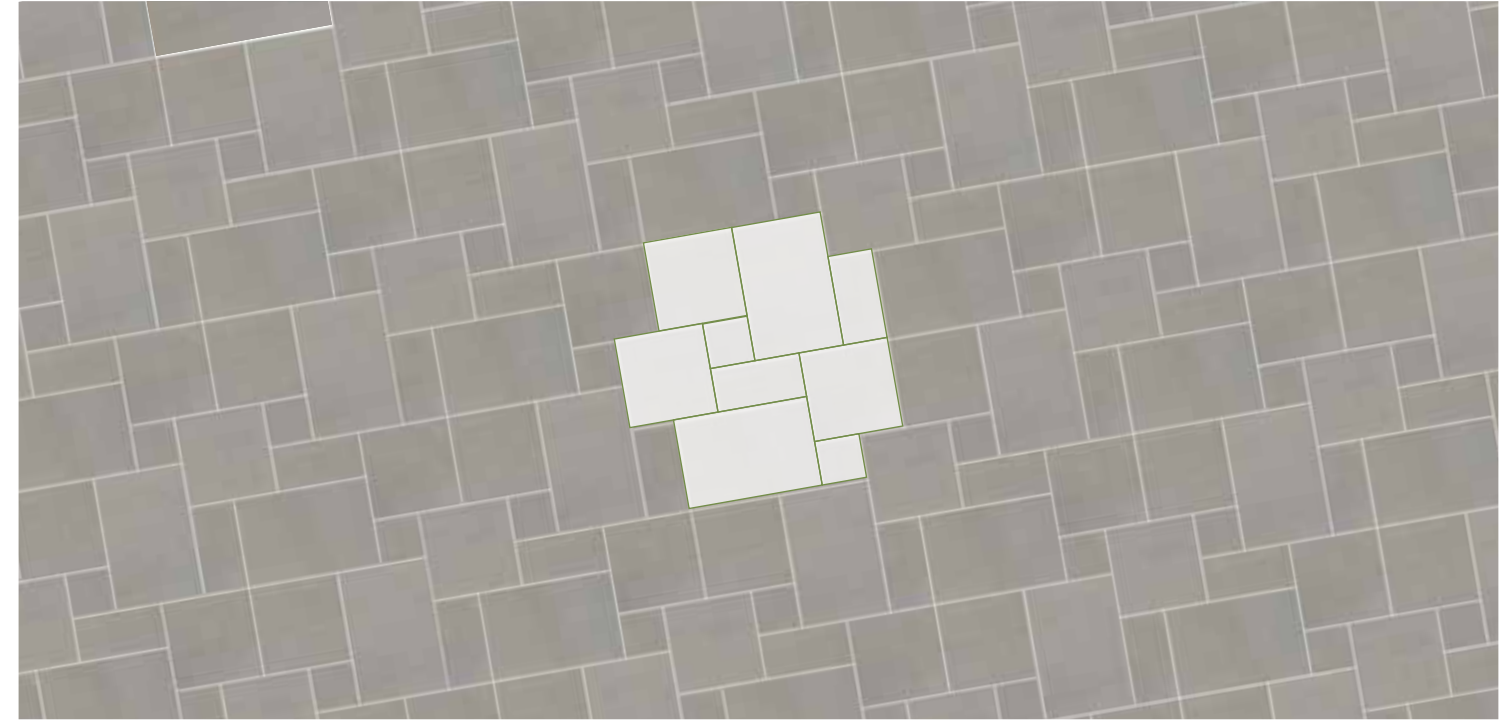

Module percentage

% HP1

24"x24" = 31%
12"x12" = 8%
24"x36" + 12"x24" (MIX) = 61% **

% HP2

24"x36" = 46%
24"x24" = 31%
12"x24" = 15%
12"x12" = 8%

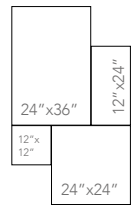

Available colors HP1

- Bluestone Blue Select
- Bluestone Full color
- Flagstone Pink-Tan
- Travertine Cross Cut White
- Travertine Cross Cut Cream
- Travertine Cross Cut Silver
- Limestone
- Michelangelo Extra White
- Arctic White
- African Beige
- Star Grey
- Indiana Buff Select
- Indiana Grey Select

Available colors HP2

- Thermal Bluestone Blue Select
- Thermal Bluestone Full Color

Module percentage

% HP1

24"x24" = 40%
12"x12" = 7%
24"x36" + 12"x24" (MIX) = 53% **

% HP2

24"x36" = 40%
24"x24" = 40%
12"x24" = 13%
12"x12" = 7%

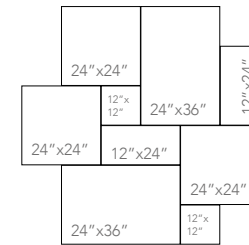

Available colors HP1

- Bluestone Blue Select
- Bluestone Full color
- Flagstone Pink-Tan
- Travertine Cross Cut White
- Travertine Cross Cut Cream
- Travertine Cross Cut Silver
- Limestone
- Michelangelo Extra White
- Arctic White
- African Beige
- Star Grey
- Indiana Buff Select
- Indiana Grey Select

Available colors HP2

- Thermal Bluestone Blue Select
- Thermal Bluestone Full Color

* Modular products with 6 mm joint (approx 1/4").

** NOTE: The 24"x36" and 12"x24" sizes (MIX) are palletized together on the same single pallet containing the correct percentages of each size.

* Modular products with 6 mm joint (approx 1/4").

** NOTE: The 24"x36" and 12"x24" sizes (MIX) are palletized together on the same single pallet containing the correct percentages of each size.

M.P.D. BIG NINE*



Module percentage

- 24"x48" = 58%
- 12"x48" = 14%
- 24"x24" = 14%
- 12"x24" = 7%
- 12"x12" = 7%

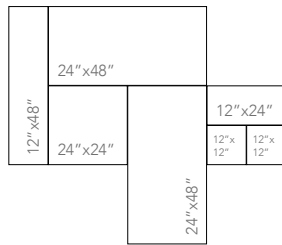

Available colors

- Bluestone Blue Select
- Bluestone Full color
- Travertine Cross Cut White
- Travertine Cross Cut Cream
- Travertine Cross Cut Silver
- Limestone
- Michelangelo Extra White
- Arctic White
- African Beige
- Star Grey
- Indiana Buff Select
- Indiana Grey Select

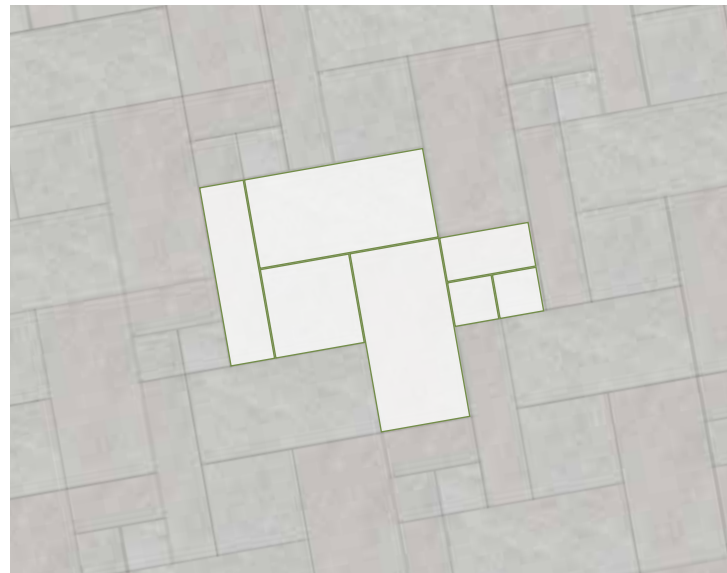

* Modular products with 6 mm joint (approx 1/4").

M.P.D. BIG TEN*



Module percentage

- 24"x48" = 58%
- 12"x48" = 14%
- 24"x24" = 14%
- 12"x24" = 14%

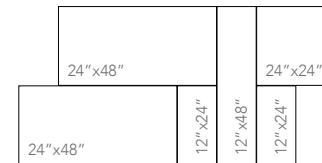

Available colors

- Bluestone Blue Select
- Bluestone Full color
- Travertine Cross Cut White
- Travertine Cross Cut Cream
- Travertine Cross Cut Silver
- Limestone
- Michelangelo Extra White
- Arctic White
- African Beige
- Star Grey
- White Avenue
- Cosmopolitan Ash
- Fashion Black
- Indiana Buff Select
- Indiana Grey Select

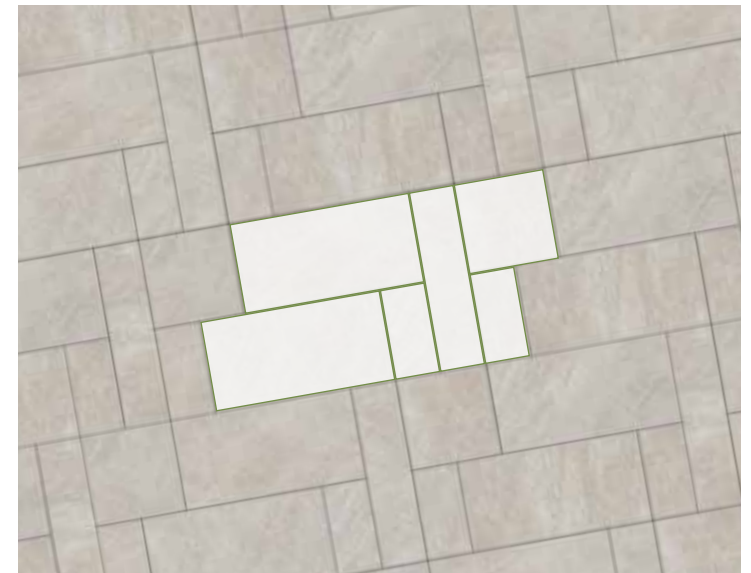

* Modular products with 6 mm joint (approx 1/4").

M.P.D. BIG ELEVEN*



Module percentage

- 24"x48" = 31%
- 12"x48" = 15%
- 24"x24" = 31%
- 12"x24" = 15%
- 12"x12" = 8%

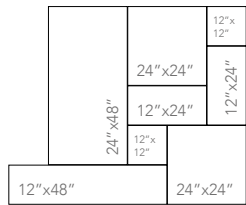

Available colors

- Bluestone Blue Select
- Bluestone Full color
- Travertine Cross Cut White
- Travertine Cross Cut Cream
- Travertine Cross Cut Silver
- Limestone
- Michelangelo Extra White
- Arctic White
- African Beige
- Star Grey
- Indiana Buff Select
- Indiana Grey Select

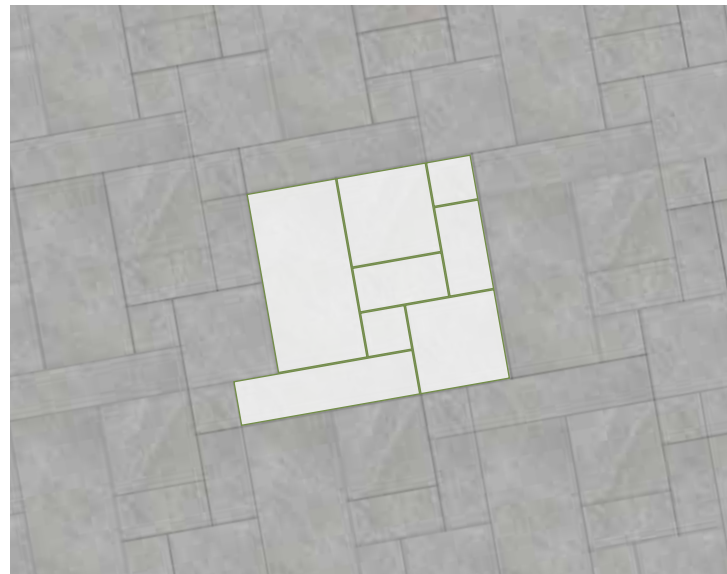

* Modular products with 6 mm joint (approx 1/4").

M.P.D. BIG TWELVE*



Module percentage

- 24"x48" = 22%
- 12"x48" = 45%
- 24"x24" = 22%
- 12"x24" = 11%

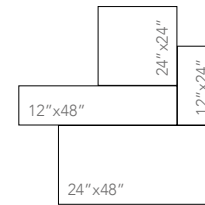

Available colors

- Bluestone Blue Select
- Bluestone Full color
- Travertine Cross Cut White
- Travertine Cross Cut Cream
- Travertine Cross Cut Silver
- Limestone
- Michelangelo Extra White
- Arctic White
- African Beige
- Star Grey
- White Avenue
- Cosmopolitan Ash
- Fashion Black
- Indiana Buff Select
- Indiana Grey Select

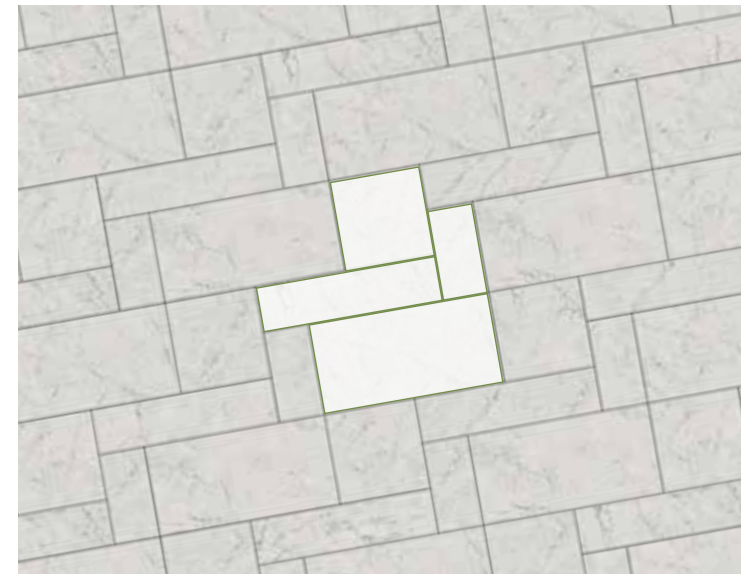

* Modular products with 6 mm joint (approx 1/4").

M.P.D. BIG THIRTEEN*



Module percentage

24"x48" = 62%
12"x48" = 30%
12"x12" = 8%

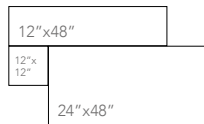

Available colors

- Bluestone Blue Select
- Bluestone Full color
- Travertine Cross Cut White
- Travertine Cross Cut Cream
- Travertine Cross Cut Silver
- Limestone
- Michelangelo Extra White
- Arctic White
- African Beige
- Star Grey
- Indiana Buff Select
- Indiana Grey Select

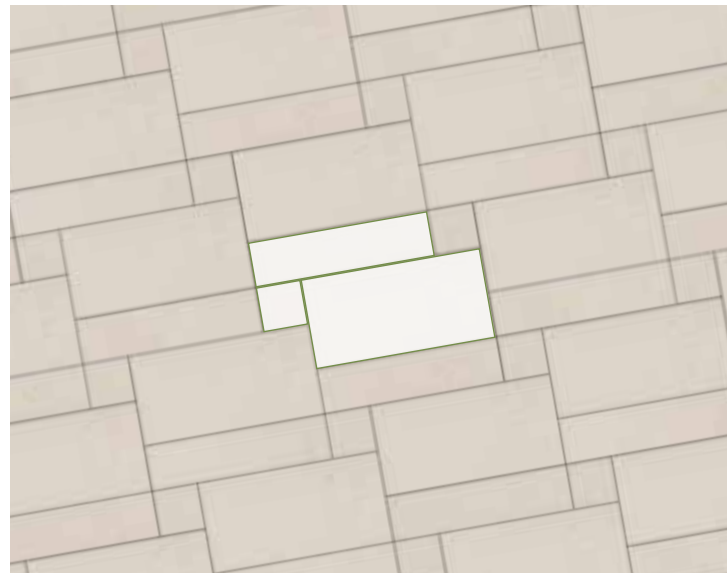

* Modular products with 6 mm joint (approx 1/4").

M.P.D. BIG FOURTEEN*



Module percentage

24"x48" = 67%
12"x48" = 33%

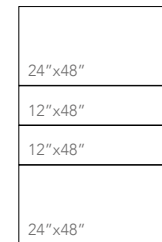

Available colors

- Bluestone Blue Select
- Bluestone Full color
- Travertine Cross Cut White
- Travertine Cross Cut Cream
- Travertine Cross Cut Silver
- Limestone
- Michelangelo Extra White
- Arctic White
- African Beige
- Star Grey
- White Avenue
- Cosmopolitan Ash
- Fashion Black
- Indiana Buff Select
- Indiana Grey Select

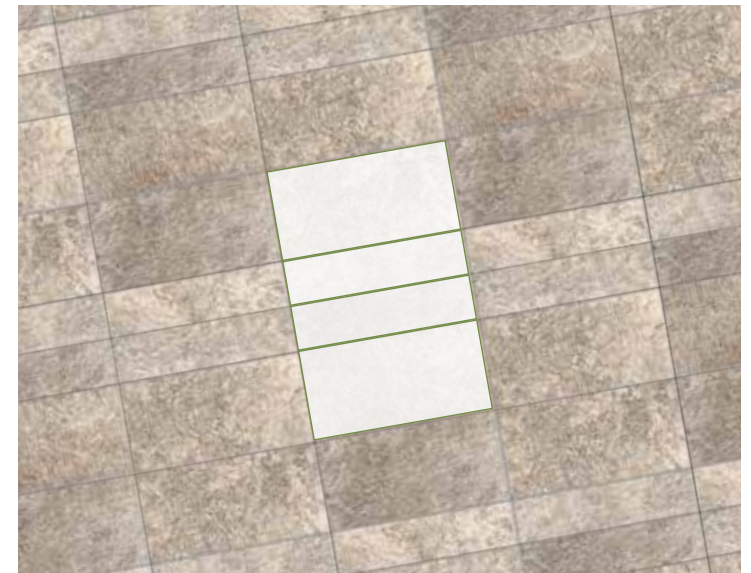

* Modular products with 6 mm joint (approx 1/4").

M.P.D. BIG FIFTEEN*



Module percentage

- 24"x48" = 38%
- 12"x48" = 19%
- 24"x24" = 19%
- 12"x24" = 19%
- 12"x12" = 5%

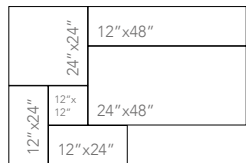

Available colors

- Bluestone Blue Select
- Bluestone Full color
- Travertine Cross Cut White
- Travertine Cross Cut Cream
- Travertine Cross Cut Silver
- Limestone
- Michelangelo Extra White
- Arctic White
- African Beige
- Star Grey
- Indiana Buff Select
- Indiana Grey Select

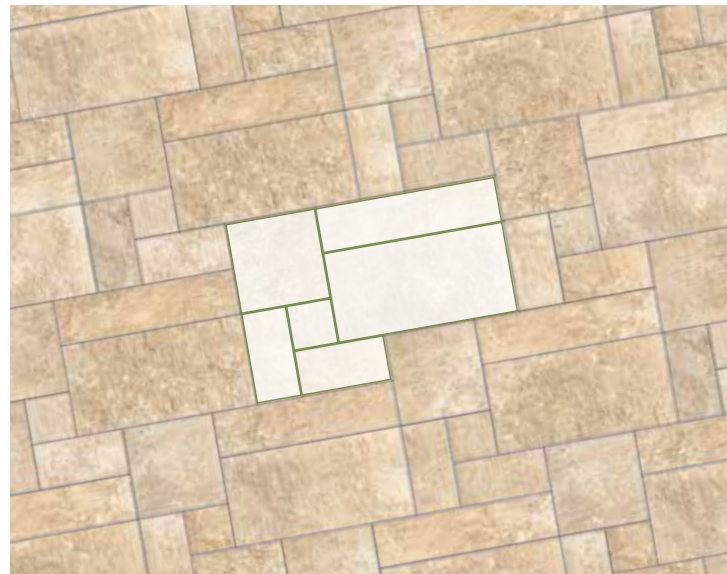

* Modular products with 6 mm joint (approx 1/4").

M.P.D. BIG SIXTEEN*



Module percentage

- 24"x48" = 31%
- 24"x24" = 31%
- 12"x24" = 23%
- 12"x12" = 15%

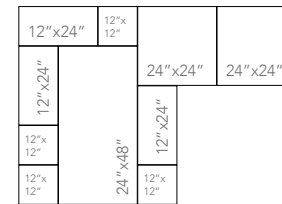

Available colors

- Bluestone Blue Select
- Bluestone Full color
- Flagstone Pink-Tan
- Travertine Cross Cut White
- Travertine Cross Cut Cream
- Travertine Cross Cut Silver
- Limestone
- Michelangelo Extra White
- Arctic White
- African Beige
- Star Grey
- Indiana Buff Select
- Indiana Grey Select

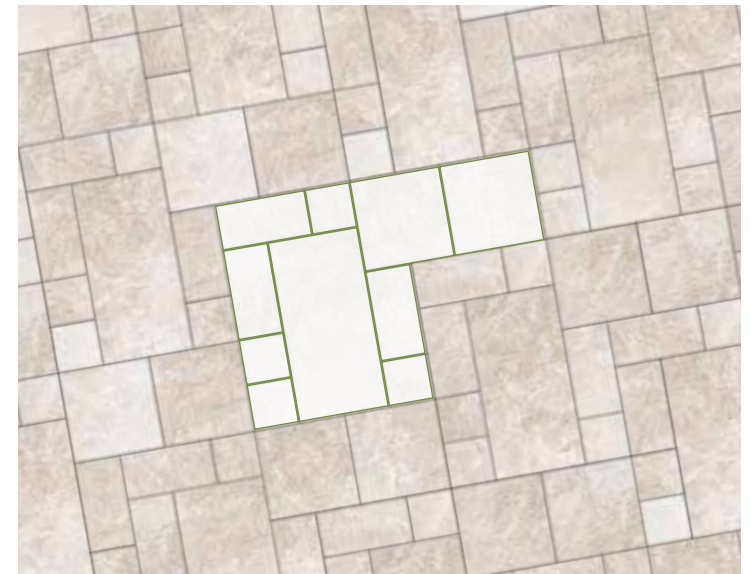

* Modular products with 6 mm joint (approx 1/4").

M.P.D. BIG SEVENTEEN*



Module percentage

- 24"x48" = 33,5%
- 12"x48" = 33,5%
- 24"x24" = 17%
- 12"x24" = 8%
- 12"x12" = 8%

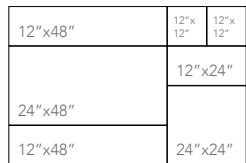

Available colors

- Bluestone Blue Select
- Bluestone Full color
- Travertine Cross Cut White
- Travertine Cross Cut Cream
- Travertine Cross Cut Silver
- Limestone
- Michelangelo Extra White
- Arctic White
- African Beige
- Star Grey
- Indiana Buff Select
- Indiana Grey Select

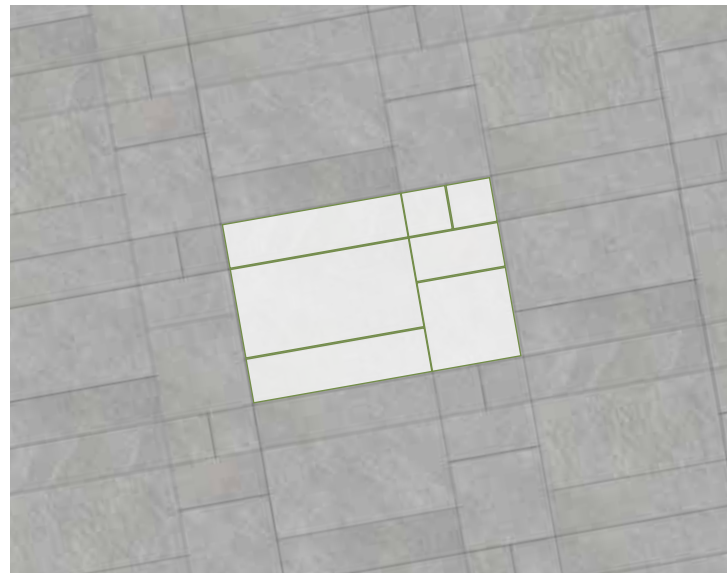

* Modular products with 6 mm joint (approx 1/4").

M.P.D. BIG EIGHTEEN*



Module percentage

- 24"x48" = 50%
- 12"x48" = 50%

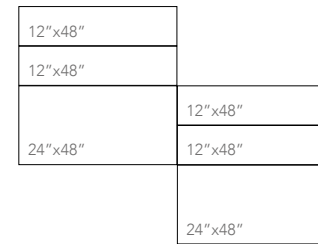

Available colors

- Bluestone Blue Select
- Bluestone Full color
- Travertine Cross Cut White
- Travertine Cross Cut Cream
- Travertine Cross Cut Silver
- Limestone
- Michelangelo Extra White
- Arctic White
- African Beige
- Star Grey
- White Avenue
- Cosmopolitan Ash
- Fashion Black
- Indiana Buff Select
- Indiana Grey Select

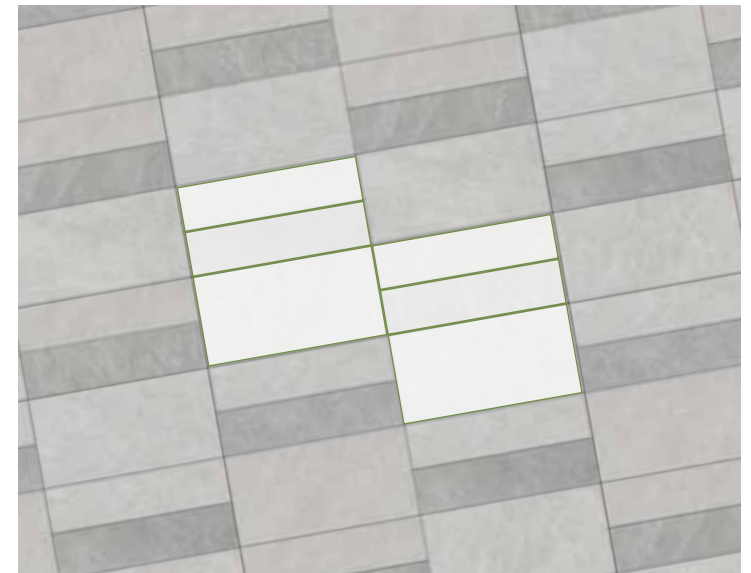

* Modular products with 6 mm joint (approx 1/4").

M.P.D. BIG NINETEEN*

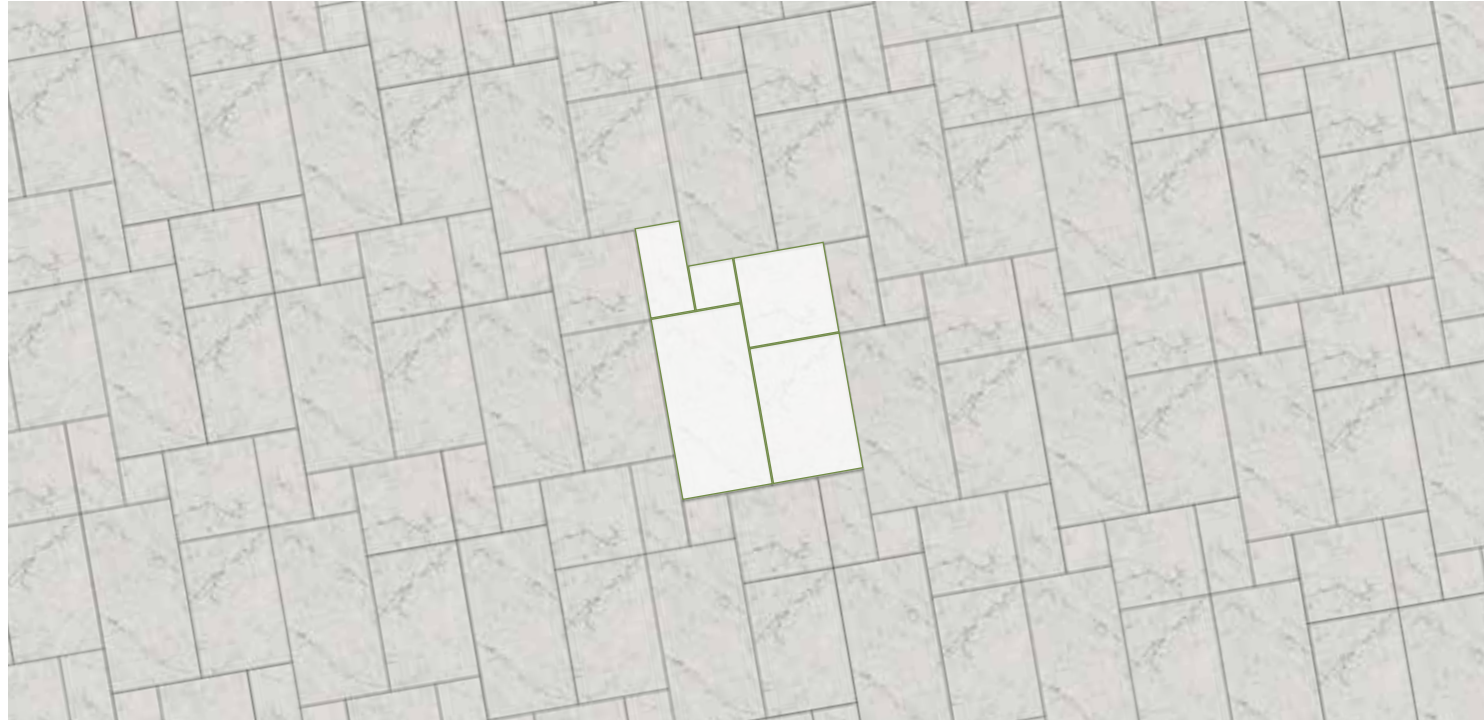

Module percentage

24"x48" = 38%
 24"x24" = 19%
 12"x12" = 5%
 24"x36" + 12"x24" (MIX) = 38% **

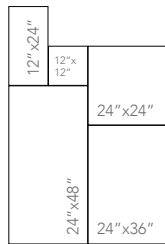

Available colors

- Bluestone Blue Select
- Bluestone Full color
- Flagstone Pink-Tan
- Travertine Cross Cut White
- Travertine Cross Cut Cream
- Travertine Cross Cut Silver
- Limestone
- Michelangelo Extra White
- Arctic White
- African Beige
- Star Grey
- Indiana Buff Select
- Indiana Grey Select

* Modular products with 6 mm joint (approx 1/4").
 ** NOTE: The 24"x36" and 12"x24" sizes (MIX) are palletized together on the same single pallet containing the correct percentages of each size.

M.P.D. BIG TWENTY*

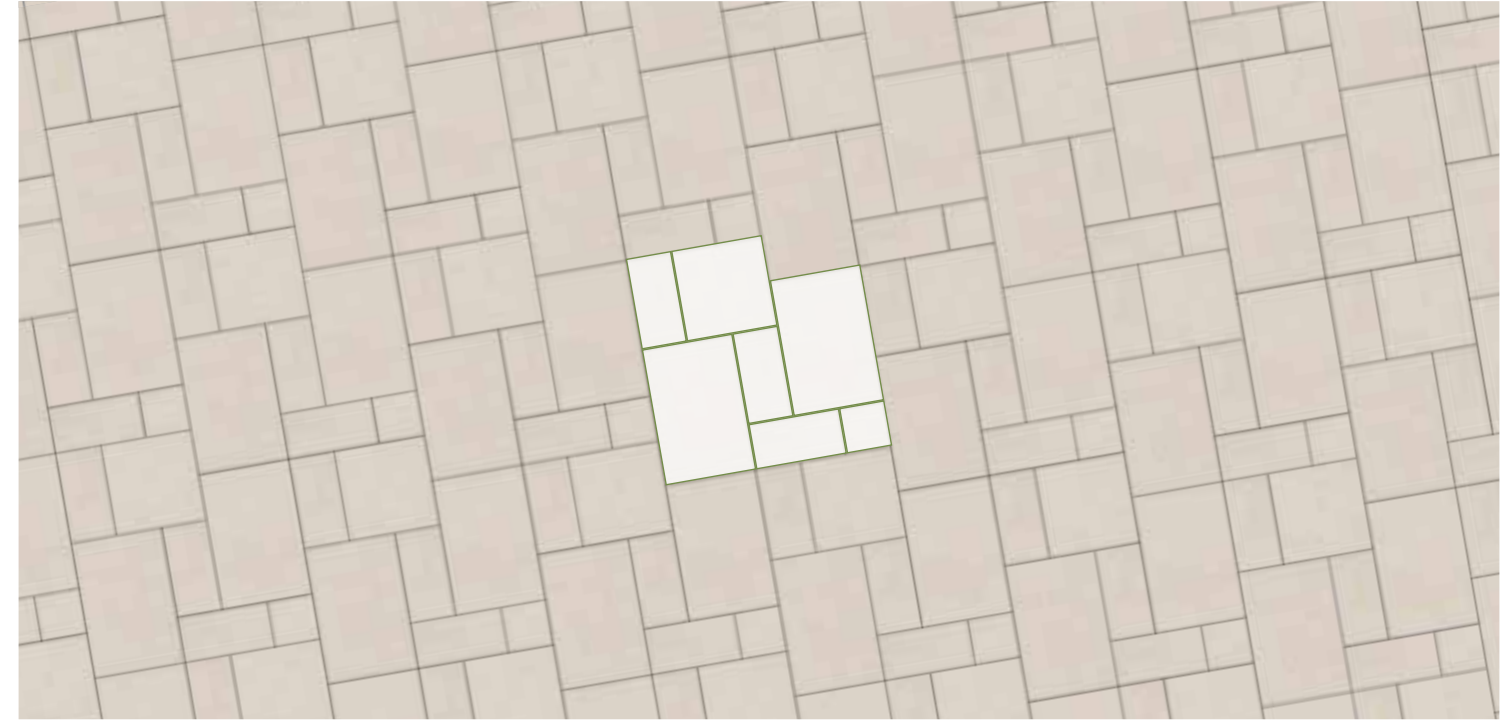

Module percentage

% HP1
 24"x24" = 18%
 12"x12" = 4%
 24"x36" + 12"x24" (MIX) = 78% **

% HP2
 24"x36" = 52%
 24"x24" = 18%
 12"x24" = 26%
 12"x12" = 4%

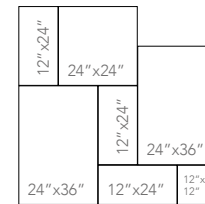

Available colors HP1

- Bluestone Blue Select
- Bluestone Full color
- Flagstone Pink-Tan
- Travertine Cross Cut White
- Travertine Cross Cut Cream
- Travertine Cross Cut Silver
- Limestone
- Michelangelo Extra White
- Arctic White
- African Beige
- Star Grey
- Indiana Buff Select
- Indiana Grey Select

Available colors HP2

- Thermal Bluestone Blue Select
- Thermal Bluestone Full Color

* Modular products with 6 mm joint (approx 1/4").
 ** NOTE: The 24"x36" and 12"x24" sizes (MIX) are palletized together on the same single pallet containing the correct percentages of each size.

M.P.D. SMALL ONE*

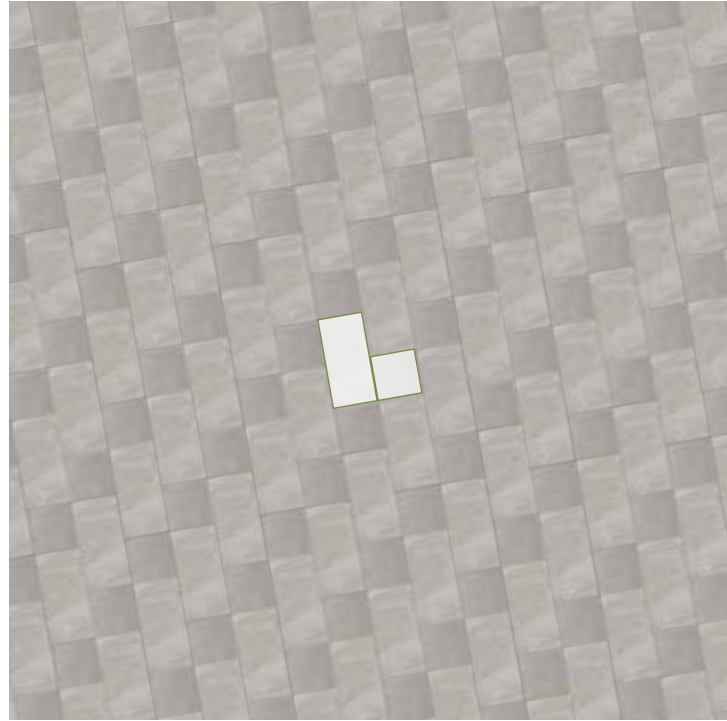

M.P.D. SMALL TWO*

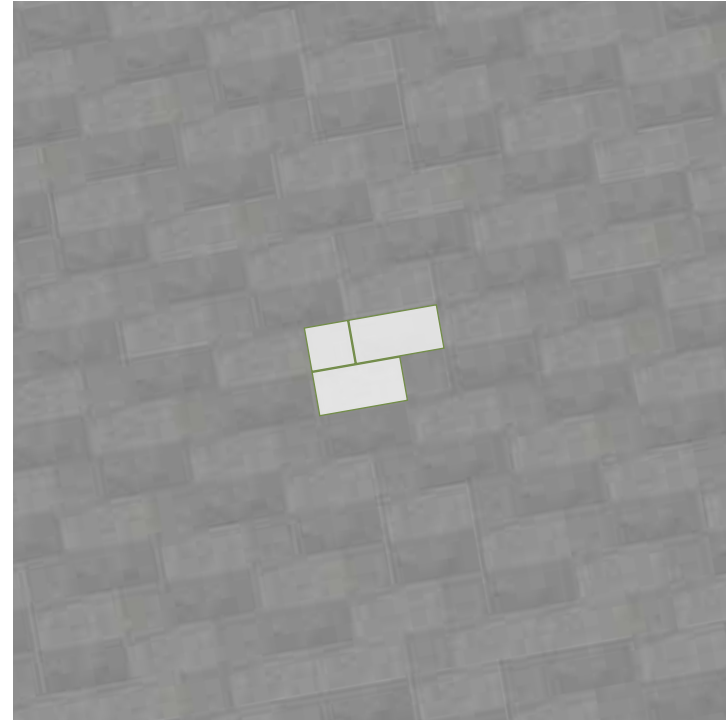

M.P.D. SMALL THREE*



M.P.D. SMALL FOUR*

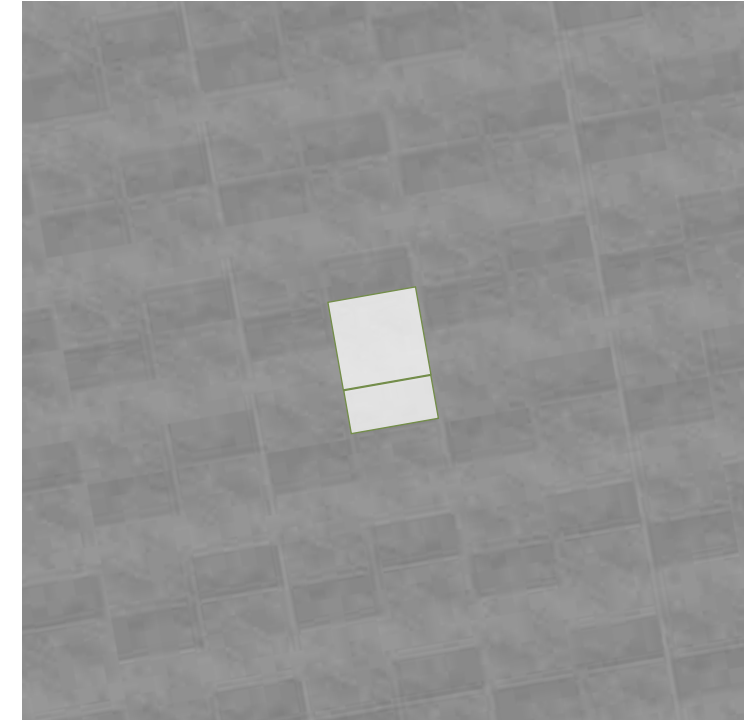

Module percentage

12"x24" = 67%
12"x12" = 33%



Available colors

- Bluestone Blue Select
- Bluestone Full color
- Thermal Bluestone Blue Select
- Thermal Bluestone Full Color
- Flagstone Pink-Tan
- Travertine Cross Cut White
- Travertine Cross Cut Cream
- Travertine Cross Cut Silver
- Limestone
- Michelangelo Extra White
- Arctic White
- African Beige
- Star Grey
- Indiana Buff Select
- Indiana Grey Select
- Indiana Variegated

Module percentage

12"x24" = 80%
12"x12" = 20%

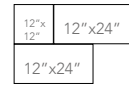

Available colors

- Bluestone Blue Select
- Bluestone Full color
- Thermal Bluestone Blue Select
- Thermal Bluestone Full Color
- Flagstone Pink-Tan
- Travertine Cross Cut White
- Travertine Cross Cut Cream
- Travertine Cross Cut Silver
- Limestone
- Michelangelo Extra White
- Arctic White
- African Beige
- Star Grey
- Indiana Buff Select
- Indiana Grey Select
- Indiana Variegated

Module percentage

24"x24" = 50%
12"x24" = 50%

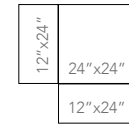

Available colors

- Bluestone Blue Select
- Bluestone Full color
- Thermal Bluestone Blue Select
- Thermal Bluestone Full Color
- Flagstone Pink-Tan
- Travertine Cross Cut White
- Travertine Cross Cut Cream
- Travertine Cross Cut Silver
- Limestone
- Michelangelo Extra White
- Arctic White
- African Beige
- Star Grey
- Vintage Slab
- Barge Gold
- Silver Quartz

Module percentage

24"x24" = 67%
12"x24" = 33%

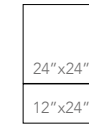

Available colors

- Bluestone Blue Select
- Bluestone Full color
- Thermal Bluestone Blue Select
- Thermal Bluestone Full Color
- Flagstone Pink-Tan
- Travertine Cross Cut White
- Travertine Cross Cut Cream
- Travertine Cross Cut Silver
- Limestone
- Michelangelo Extra White
- Arctic White
- African Beige
- Star Grey
- Vintage Slab
- Barge Gold
- Silver Quartz

* Modular products with 6 mm joint (approx 1/4").

* Modular products with 6 mm joint (approx 1/4").

M.P.D. SMALL FIVE*

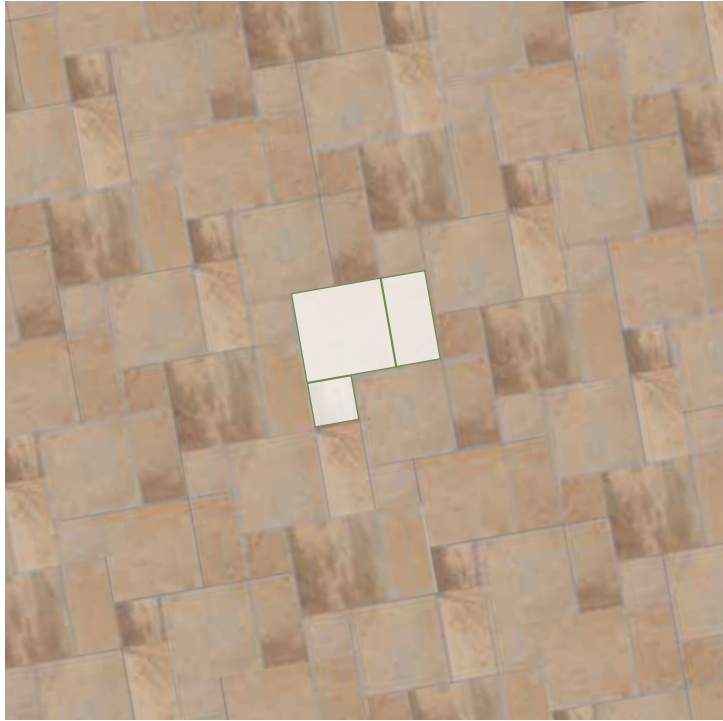

M.P.D. SMALL SIX*

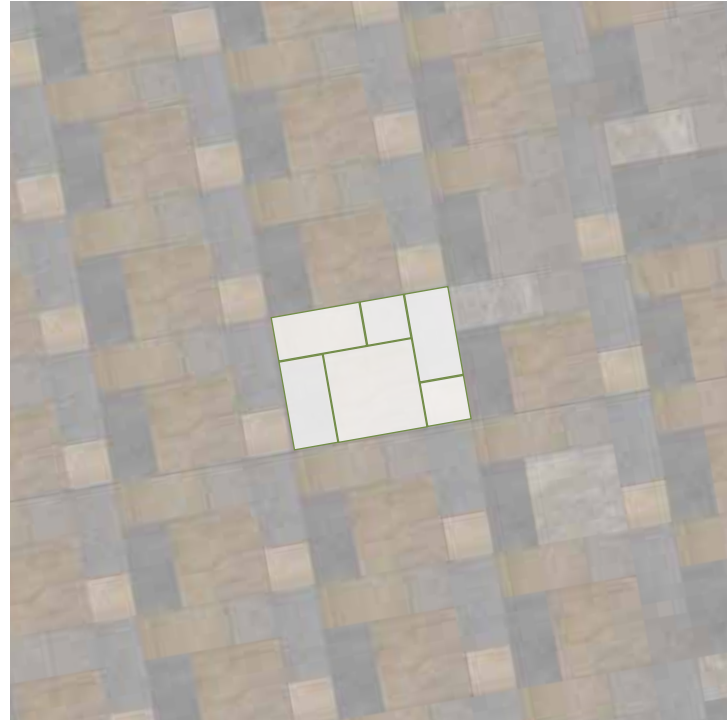

M.P.D. SMALL SEVEN*

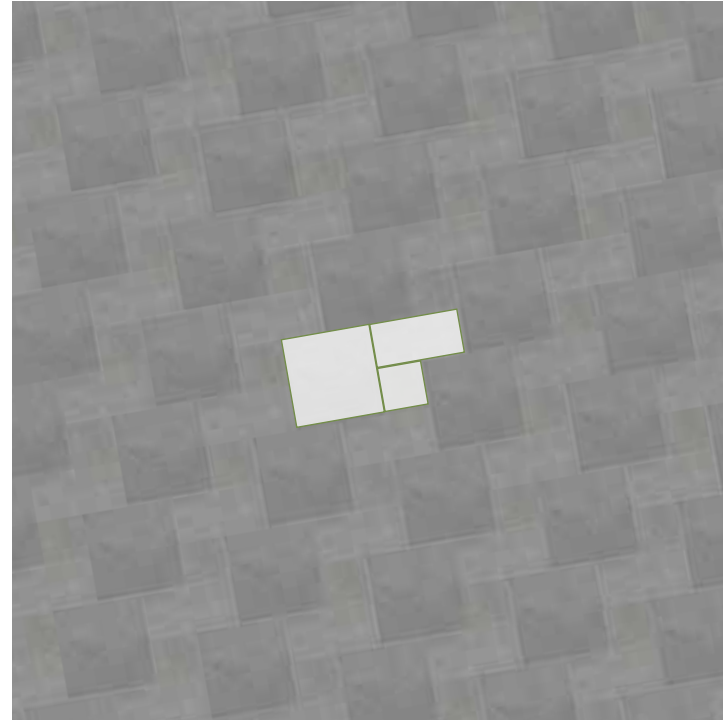

M.P.D. SMALL EIGHT*

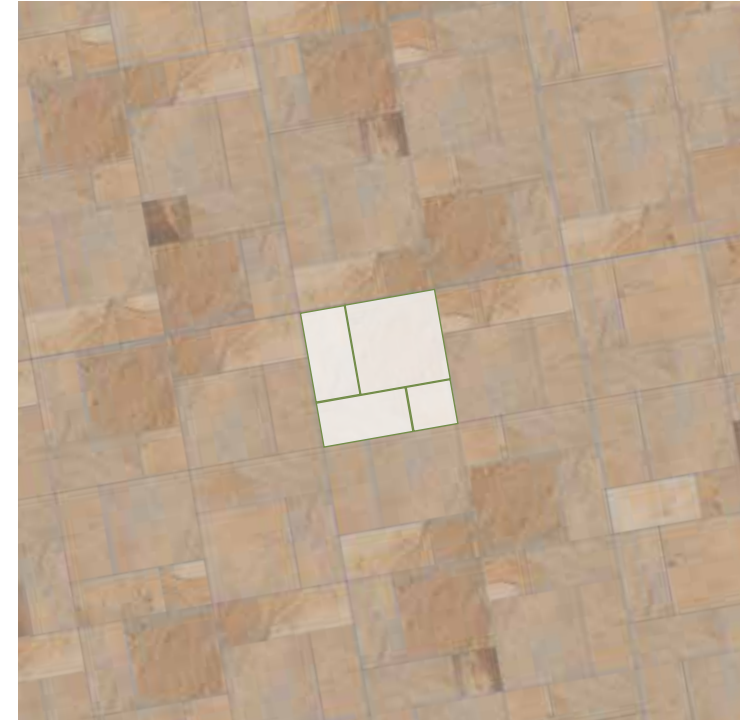

Module percentage

24"x24" = 57%
12"x24" = 29%
12"x12" = 14%

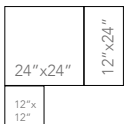

Available colors

- Bluestone Blue Select
- Bluestone Full color
- Thermal Bluestone Blue Select
- Thermal Bluestone Full Color
- Flagstone Pink-Tan
- Travertine Cross Cut White
- Travertine Cross Cut Cream
- Travertine Cross Cut Silver
- Limestone
- Michelangelo Extra White
- Arctic White
- African Beige
- Star Grey
- Indiana Buff Select
- Indiana Grey Select
- Indiana Variegated

Module percentage

24"x24" = 33%
12"x24" = 50%
12"x12" = 17%

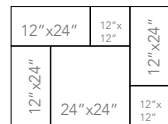

Available colors

- Bluestone Blue Select
- Bluestone Full color
- Thermal Bluestone Blue Select
- Thermal Bluestone Full Color
- Flagstone Pink-Tan
- Travertine Cross Cut White
- Travertine Cross Cut Cream
- Travertine Cross Cut Silver
- Limestone
- Michelangelo Extra White
- Arctic White
- African Beige
- Star Grey
- Indiana Buff Select
- Indiana Grey Select
- Indiana Variegated

Module percentage

24"x24" = 57%
12"x24" = 29%
12"x12" = 14%

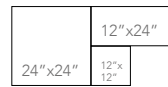

Available colors

- Bluestone Blue Select
- Bluestone Full color
- Thermal Bluestone Blue Select
- Thermal Bluestone Full Color
- Flagstone Pink-Tan
- Travertine Cross Cut White
- Travertine Cross Cut Cream
- Travertine Cross Cut Silver
- Limestone
- Michelangelo Extra White
- Arctic White
- African Beige
- Star Grey
- Indiana Buff Select
- Indiana Grey Select
- Indiana Variegated

Module percentage

24"x24" = 44%
12"x24" = 45%
12"x12" = 11%

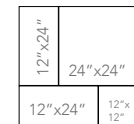

Available colors

- Bluestone Blue Select
- Bluestone Full color
- Thermal Bluestone Blue Select
- Thermal Bluestone Full Color
- Flagstone Pink-Tan
- Travertine Cross Cut White
- Travertine Cross Cut Cream
- Travertine Cross Cut Silver
- Limestone
- Michelangelo Extra White
- Arctic White
- African Beige
- Star Grey
- Indiana Buff Select
- Indiana Grey Select
- Indiana Variegated

* Modular products with 6 mm joint (approx 1/4").

* Modular products with 6 mm joint (approx 1/4").

M.P.D. SMALL NINE*

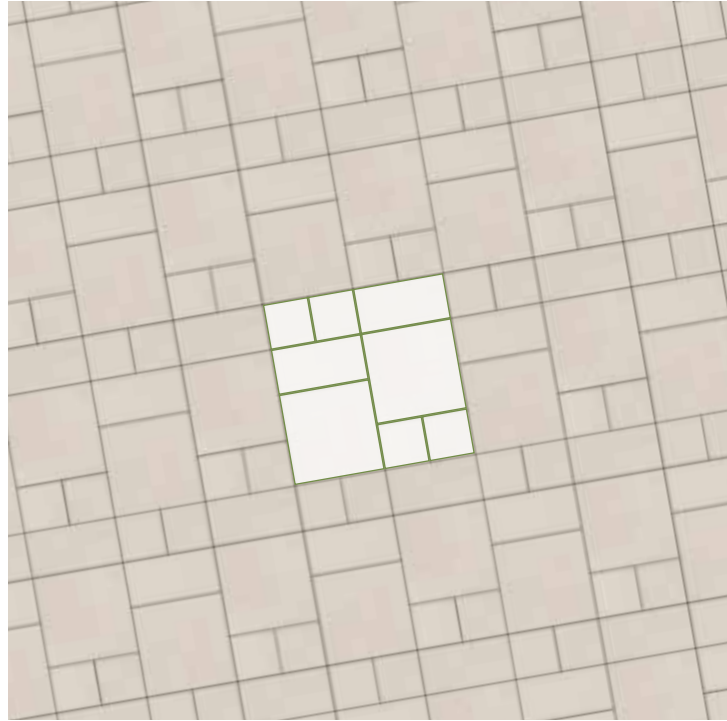

Module percentage

24"x24" = 50%
12"x24" = 25%
12"x12" = 25%

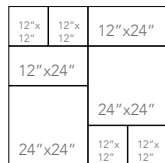

Available colors

- Bluestone Blue Select
- Bluestone Full color
- Thermal Bluestone Blue Select
- Thermal Bluestone Full Color
- Flagstone Pink-Tan
- Travertine Cross Cut White
- Travertine Cross Cut Cream
- Travertine Cross Cut Silver
- Limestone
- Michelangelo Extra White
- Arctic White
- African Beige
- Star Grey
- Indiana Buff Select
- Indiana Grey Select
- Indiana Variegated

M.P.D. SMALL TEN*

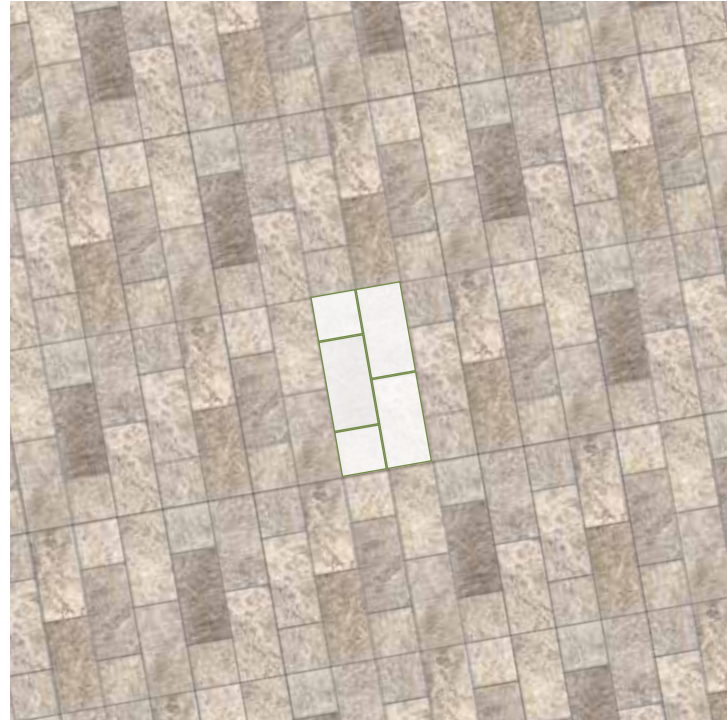

Module percentage

12"x24" = 75%
12"x12" = 25%

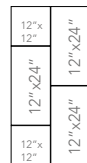

Available colors

- Bluestone Blue Select
- Bluestone Full color
- Thermal Bluestone Blue Select
- Thermal Bluestone Full Color
- Flagstone Pink-Tan
- Travertine Cross Cut White
- Travertine Cross Cut Cream
- Travertine Cross Cut Silver
- Limestone
- Michelangelo Extra White
- Arctic White
- African Beige
- Star Grey
- Indiana Buff Select
- Indiana Grey Select
- Indiana Variegated



PROJECT

OUTDOOR FLOOR DESIGN
Frontier20 Travertine Cross Cut Silver - 24"x24"
Frontier20 Travertine Cross Cut Silver - 12"x24"
WALL DESIGN
Brick World Soho Black - 3"x12"

* Modular products with 6 mm joint (approx 1/4").

M.P.D. MINI ONE*

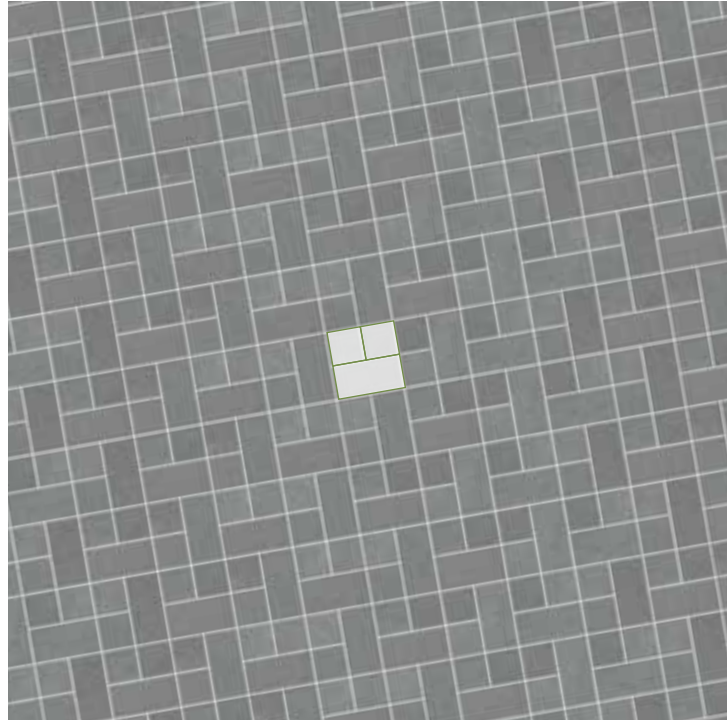

Module percentage

9"x18" = 50%
9"x9" = 50%



Available color

● Tumbled Bluestone

M.P.D. MINI TWO*

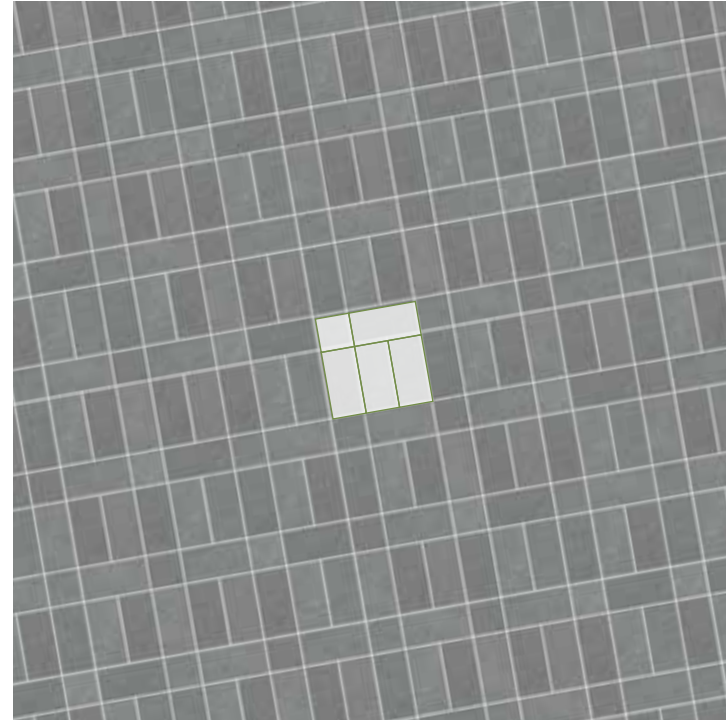

Module percentage

9"x18" = 89%
9"x9" = 11%



Available color

● Tumbled Bluestone

M.P.D. MINI THREE*

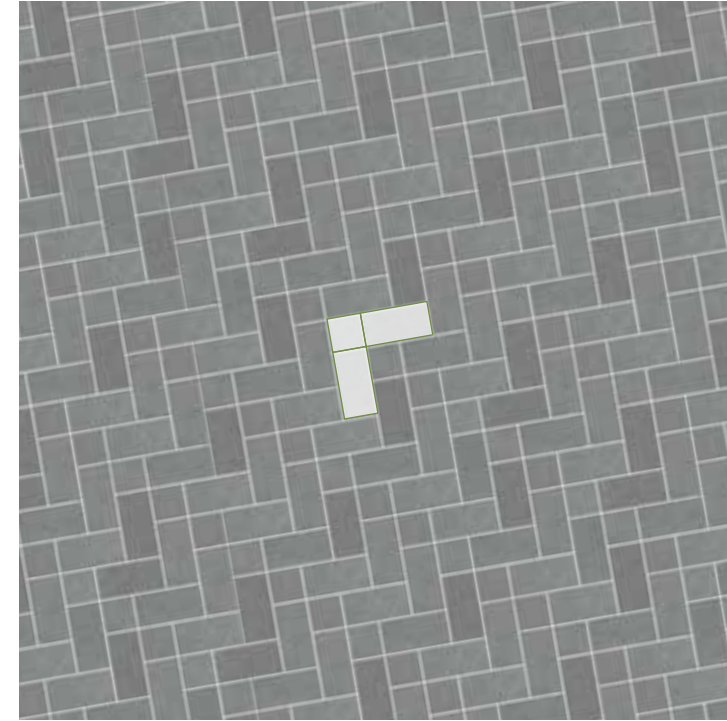

Module percentage

9"x18" = 80%
9"x9" = 20%

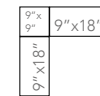

Available color

● Tumbled Bluestone

M.P.D. MINI FOUR*

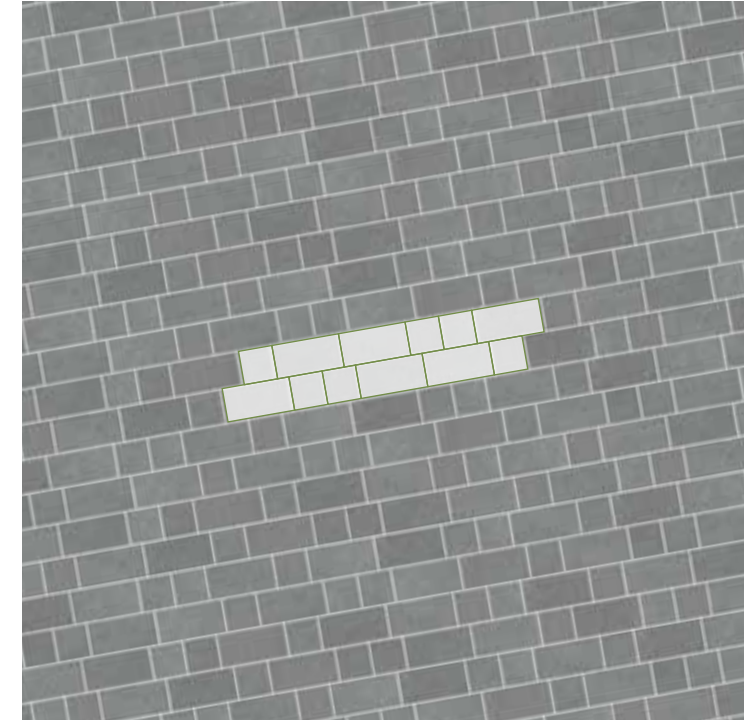

Module percentage

9"x18" = 67%
9"x9" = 33%

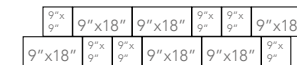

Available color

● Tumbled Bluestone

* Modular products with 6 mm joint (approx 1/4").

* Modular products with 6 mm joint (approx 1/4").

PRODUCT RANGE.

PROJECT

FLOOR DESIGN

Frontier20 Essence Brown - 12"x48"

Frontier20 Essence Brown Stair Tread - 12"x48"

Frontier20 Essence Brown Coping Corner - 12"x48"

Frontier20 Essence Brown Riser - 6"x48"

BLUESTONE DESIGN PROJECT

THERMAL BLUESTONE
BLUE SELECT

AMERICANSTONE ★

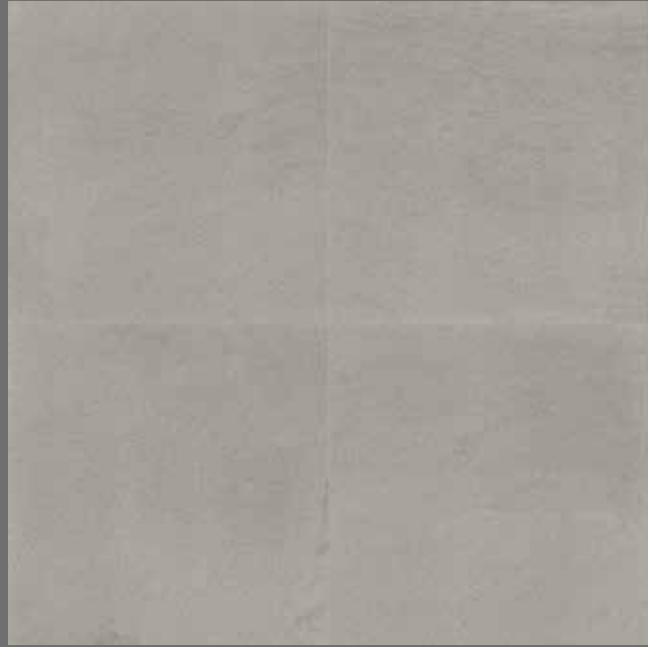

Available sizes

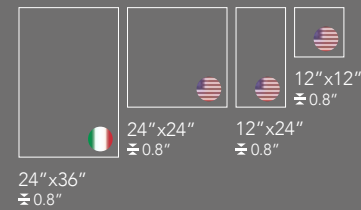

Color shading



BLUESTONE BLUE SELECT

AMERICANSTONE ★



Available sizes

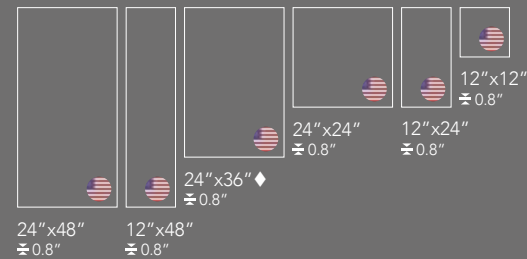

Color shading



BLUESTONE DESIGN PROJECT

BLUE SELECT BLUESTONE
COBBLESTONE CUBE

AMERICANSTONE ★

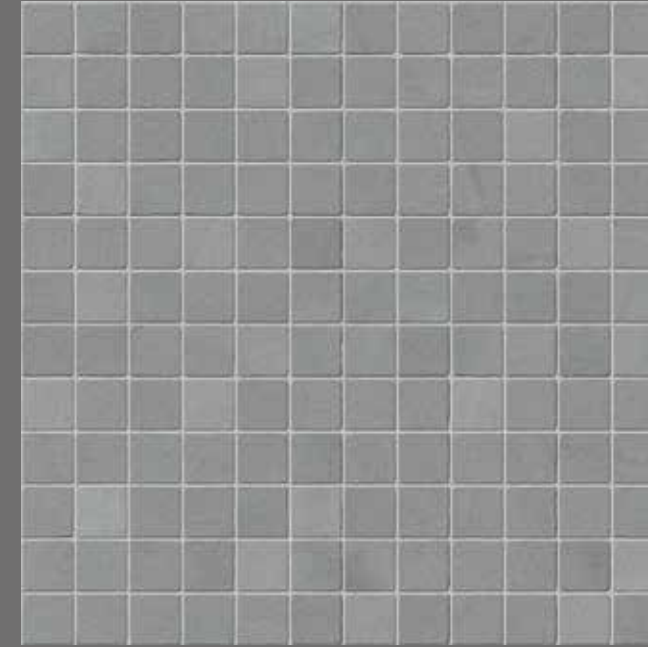

Available size



Color shading



BLUE SELECT BLUESTONE
COBBLESTONE MULTISIZE

AMERICANSTONE ★

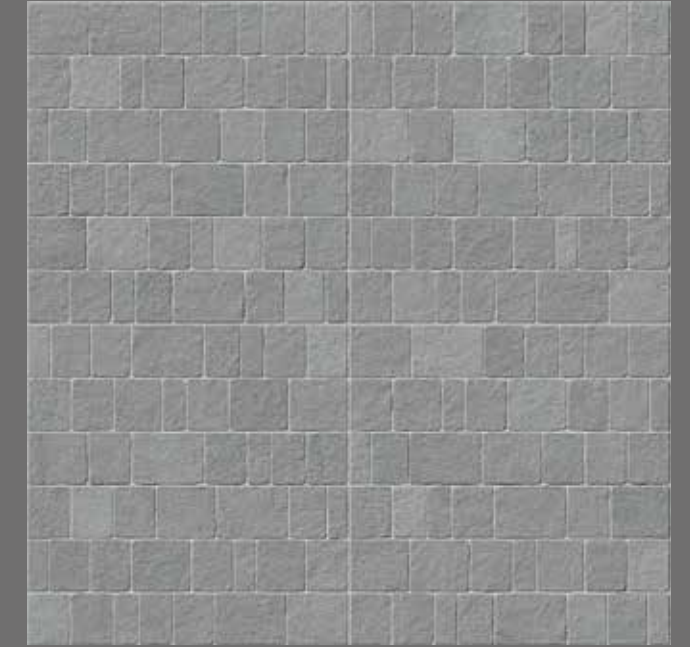

Available size



Color shading



The color of pavers printed in this catalog may differ from actual pavers. Paver color reproductions in this catalog are representative only. Slight tone and shade variations are inherent in porcelain pavers. Before selecting a color, we recommend that you contact your local representative, who will provide you with a sample piece of the requested paver.

This porcelain paver product is manufactured with a V2 shade variation. Remember that the amount of color as well as the texture of each piece may vary from paver to paver. Inspect the product immediately upon delivery and select pavers from many boxes during installation to minimize and blend any possible color difference.

Color Shading



◆ NOTE: 24"x36" is sold as mix (24"x36" + 12"x24") along with 12"x24". The two sizes are palletized on the same pallet and sold together.



BLUESTONE DESIGN PROJECT

THERMAL BLUESTONE
FULL COLOR

AMERICANSTONE ★



Available sizes

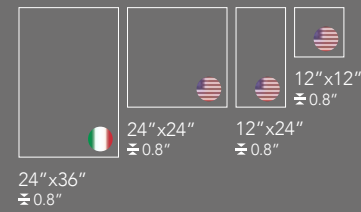

Color shading



BLUESTONE FULL COLOR

AMERICANSTONE ★



Available sizes

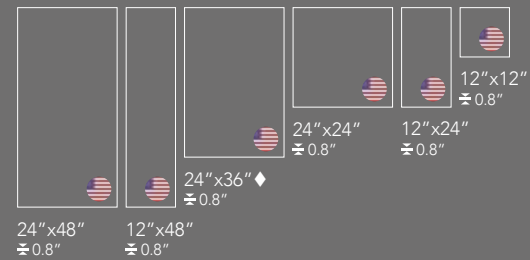

Color shading



BLUESTONE DESIGN PROJECT

FULL COLOR BLUESTONE
COBBLESTONE CUBE

AMERICANSTONE ★

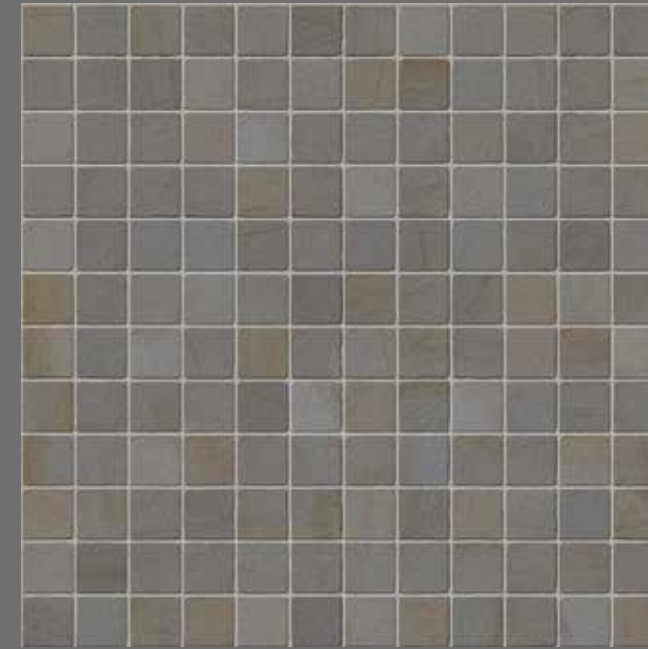

Available size



Color shading



FULL COLOR BLUESTONE
COBBLESTONE MULTISIZE

AMERICANSTONE ★



Available size



Color shading



The color of pavers printed in this catalog may differ from actual pavers. Paver color reproductions in this catalog are representative only. Slight tone and shade variations are inherent in porcelain pavers. Before selecting a color, we recommend that you contact your local representative, who will provide you with a sample piece of the requested paver.

This porcelain paver product is manufactured with a V3/V4 shade variation. Remember that the amount of color as well as the texture of each piece may vary from paver to paver. Inspect the product immediately upon delivery and select pavers from many boxes during installation to minimize and blend any possible color difference.

Color Shading



◆ NOTE: 24"x36" is sold as mix (24"x36" + 12"x24") along with 12"x24". The two sizes are palletized on the same pallet and sold together.

BLUESTONE DESIGN PROJECT

TUMBLLED BLUESTONE

AMERICANSTONE ★



Available sizes



Color shading



TUMBLLED BLUESTONE
COBBLESTONE CUBE

AMERICANSTONE ★

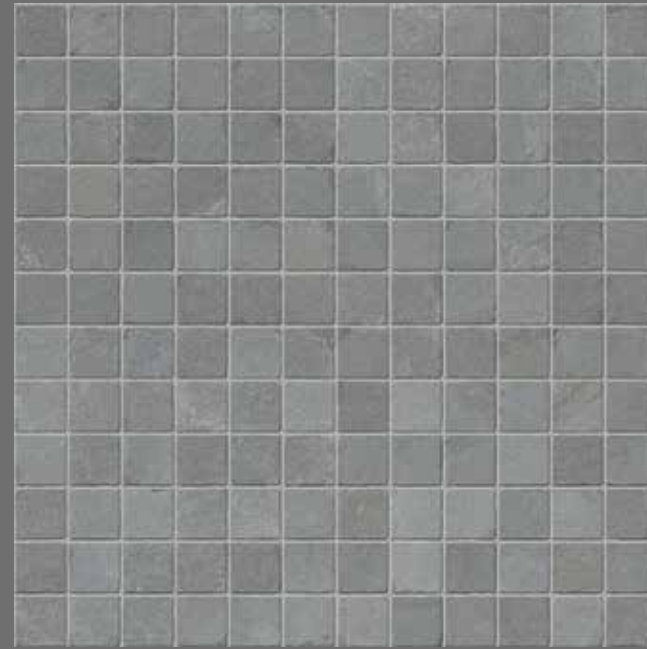

Available size

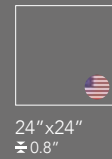

Color shading



BLUESTONE DESIGN PROJECT

TUMBLLED BLUESTONE
COBBLESTONE MULTISIZE

AMERICANSTONE ★

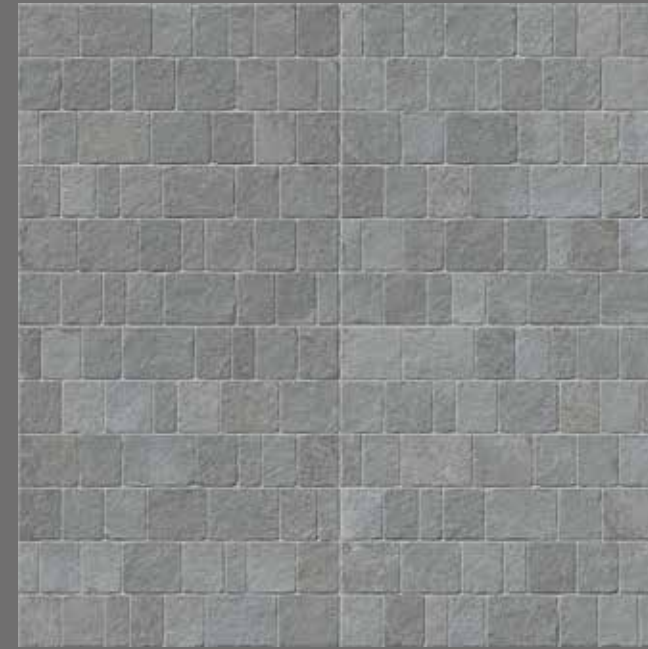

Available size



Color shading



The color of pavers printed in this catalog may differ from actual pavers. Paver color reproductions in this catalog are representative only. Slight tone and shade variations are inherent in porcelain pavers. Before selecting a color, we recommend that you contact your local representative, who will provide you with a sample piece of the requested paver.

This porcelain paver product is manufactured with a V3 shade variation. Remember that the amount of color as well as the texture of each piece may vary from paver to paver. Inspect the product immediately upon delivery and select pavers from many boxes during installation to minimize and blend any possible color difference.

Color Shading



FLAGSTONE LOOK

FLAGSTONE BROWN

AMERICANSTONE ★



Available size



24" x 24"
± 0.8"

Color shading



V3

◆ NOTE: 24"x36" is sold as mix (24"x36" + 12"x24") along with 12"x24".
The two sizes are palletized on the same pallet and sold together.

The color of pavers printed in this catalog may differ from actual pavers. Paver color reproductions in this catalog are representative only. Slight tone and shade variations are inherent in porcelain pavers. Before selecting a color, we recommend that you contact your local representative, who will provide you with a sample piece of the requested paver.

This porcelain paver product is manufactured with a V3/V4 shade variation. Remember that the amount of color as well as the texture of each piece may vary from paver to paver. Inspect the product immediately upon delivery and select pavers from many boxes during installation to minimize and blend any possible color difference.

LIMESTONE LOOK

LIMESTONE

AMERICANSTONE ★



Available sizes



24" x 48"
± 0.8"



12" x 48"
± 0.8"



24" x 36" ◆
± 0.8"

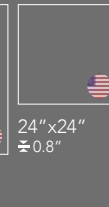

24" x 24"
± 0.8"



12" x 24"
± 0.8"

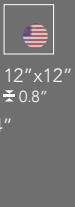

12" x 12"
± 0.8"

Color shading



V2

◆ NOTE: 24"x36" is sold as mix (24"x36" + 12"x24") along with 12"x24".
The two sizes are palletized on the same pallet and sold together.

Color Shading



V1
UNIFORM APPEARANCE



V2
SLIGHT VARIATION



V3
MODERATE VARIATION



V4
SUBSTANTIAL VARIATION

SLATE LOOK

MULTICOLOR GOLD

AMERICANSTONE ★



Available size

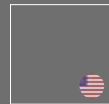

24" x 24"
± 0.8"

Color shading



MULTICOLOR DARK

AMERICANSTONE ★

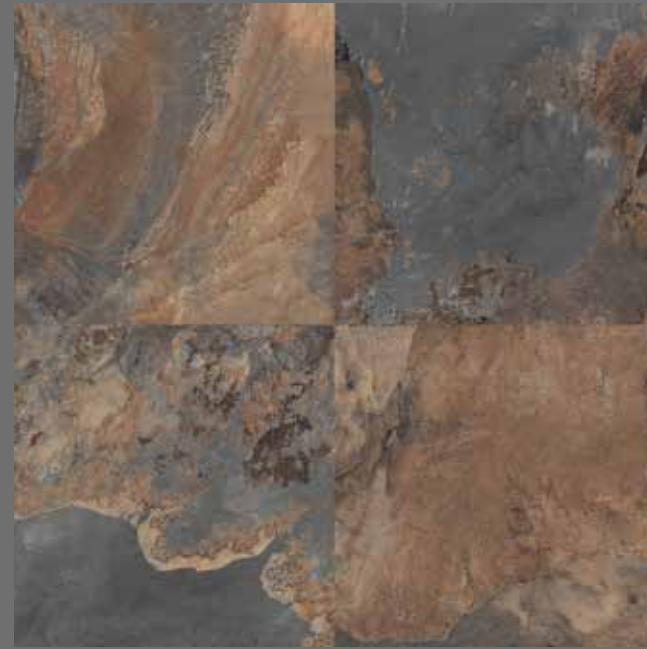

Available size



24" x 24"
± 0.8"

Color shading



SLATE LOOK

VINTAGE SLAB

AMERICANSTONE ★



Available sizes

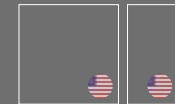

24" x 24"
± 0.8" 12" x 24"
± 0.8"

Color shading



The color of pavers printed in this catalog may differ from actual pavers. Paver color reproductions in this catalog are representative only. Slight tone and shade variations are inherent in porcelain pavers. Before selecting a color, we recommend that you contact your local representative, who will provide you with a sample piece of the requested paver.

This porcelain paver product is manufactured with a V2/V3 shade variation. Remember that the amount of color as well as the texture of each piece may vary from paver to paver. Inspect the product immediately upon delivery and select pavers from many boxes during installation to minimize and blend any possible color difference.

Color Shading



TRAVERTINE CROSS CUT DESIGN PROJECT

TRAVERTINE CROSS CUT WHITE AMERICANSTONE ★



Available sizes

Color shading

24" x 48" ±0.8"

12" x 48" ±0.8"

24" x 36" ±0.8" ♦

24" x 24" ±0.8"

12" x 24" ±0.8"

12" x 12" ±0.8"

V2

TRAVERTINE CROSS CUT SILVER AMERICANSTONE ★



Available sizes

Color shading

24" x 48" ±0.8"

12" x 48" ±0.8"

24" x 36" ±0.8" ♦

24" x 24" ±0.8"

12" x 24" ±0.8"

12" x 12" ±0.8"

V2

TRAVERTINE CROSS CUT DESIGN PROJECT

TRAVERTINE CROSS CUT CREAM AMERICANSTONE ★



Available sizes

Color shading

24" x 48" ±0.8"

12" x 48" ±0.8"

24" x 36" ±0.8" ♦

24" x 24" ±0.8"

12" x 24" ±0.8"

12" x 12" ±0.8"

V2

TRAVERTINE CROSS CUT NOCE AMERICANSTONE ★



Available size

Color shading

24" x 24" ±0.8"

V2

The color of pavers printed in this catalog may differ from actual pavers. Paver color reproductions in this catalog are representative only. Slight tone and shade variations are inherent in porcelain pavers. Before selecting a color, we recommend that you contact your local representative, who will provide you with a sample piece of the requested paver.

This porcelain paver product is manufactured with a V2 shade variation. Remember that the amount of color as well as the texture of each piece may vary from paver to paver. Inspect the product immediately upon delivery and select pavers from many boxes during installation to minimize and blend any possible color difference.

Color Shading

V1 UNIFORM APPEARANCE

V2 SLIGHT VARIATION

V3 MODERATE VARIATION

V4 SUBSTANTIAL VARIATION

♦ NOTE: 24"x36" is sold as mix (24"x36" + 12"x24") along with 12"x24". The two sizes are palletized on the same pallet and sold together.

INDIANA SALEM DESIGN PROJECT

INDIANA BUFF SELECT

AMERICANSTONE ★

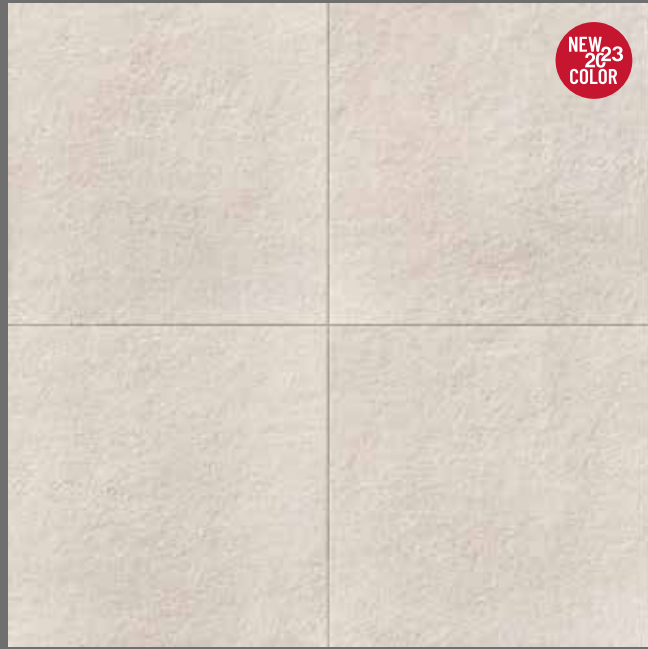

Available sizes

Color shading

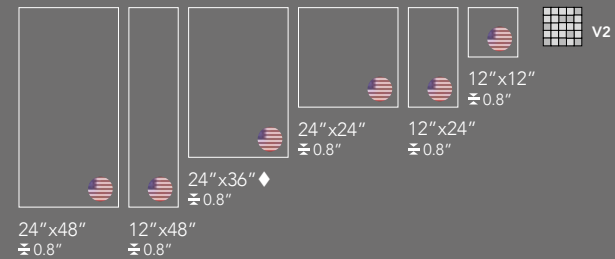

INDIANA GREY SELECT

AMERICANSTONE ★



Available sizes

Color shading

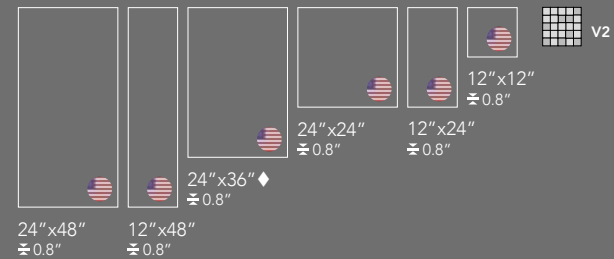

INDIANA SALEM DESIGN PROJECT

INDIANA VARIEGATED

AMERICANSTONE ★



Available sizes

Color shading



The color of pavers printed in this catalog may differ from actual pavers. Paver color reproductions in this catalog are representative only. Slight tone and shade variations are inherent in porcelain pavers. Before selecting a color, we recommend that you contact your local representative, who will provide you with a sample piece of the requested paver.

This porcelain paver product is manufactured with a V2 shade variation. Remember that the amount of color as well as the texture of each piece may vary from paver to paver. Inspect the product immediately upon delivery and select pavers from many boxes during installation to minimize and blend any possible color difference.

Color Shading



♦ NOTE: 24"x36" is sold as mix (24"x36" + 12"x24") along with 12"x24". The two sizes are palletized on the same pallet and sold together.



STONE LOOK

WHITE AVENUE

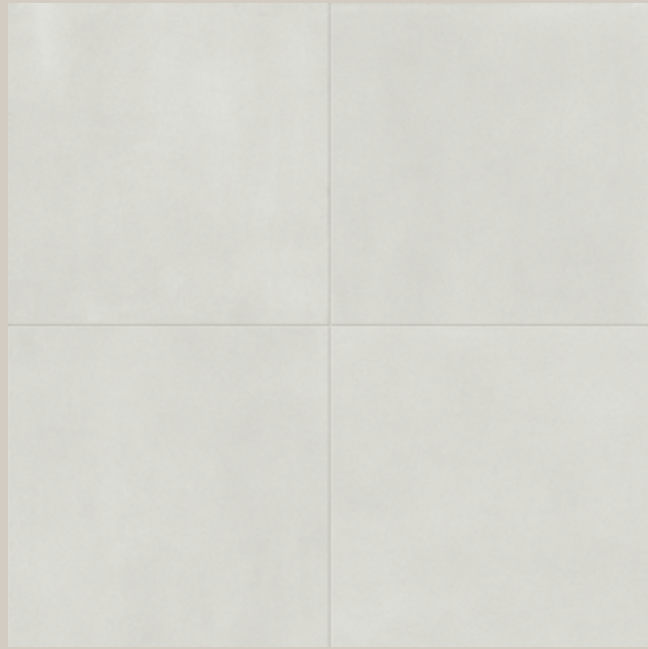

Available size

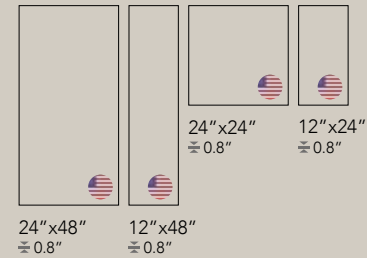

Color shading



COSMOPOLITAN ASH

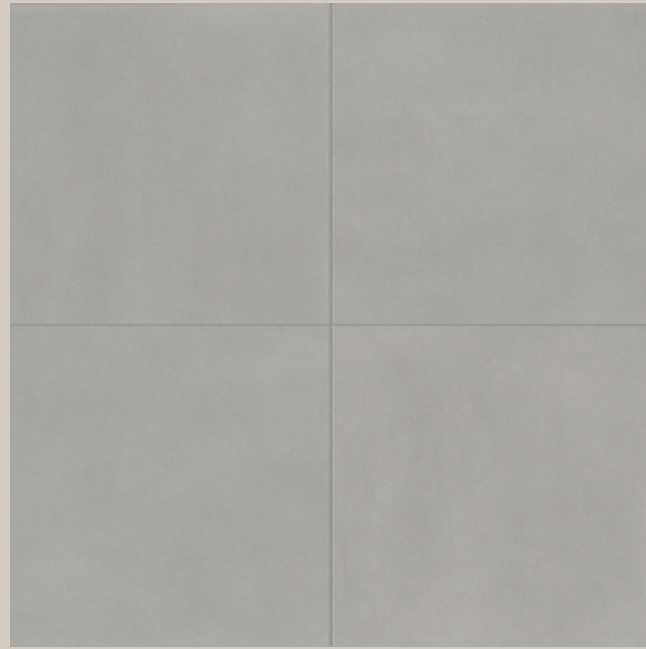

Available size

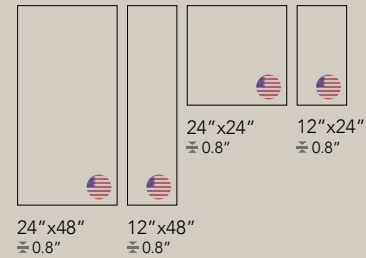

Color shading



STONE LOOK

ARTISTIC BEIGE

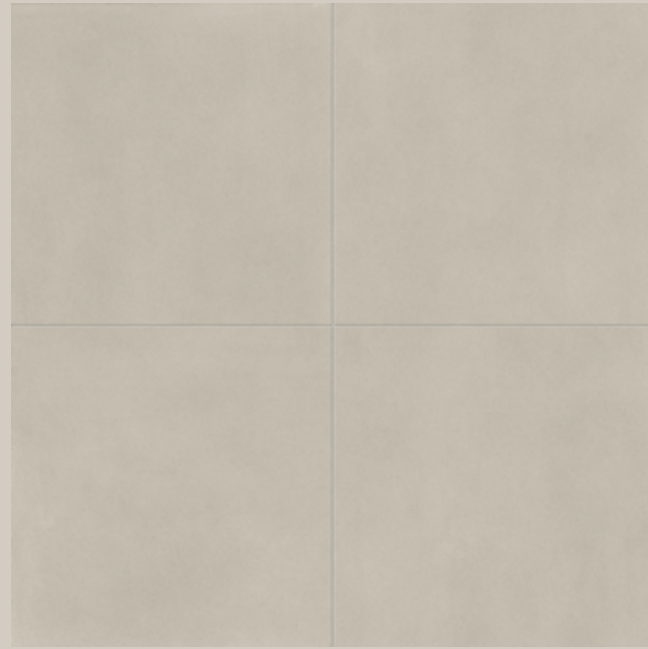

Available size

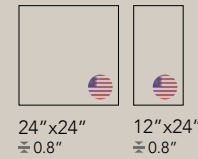

Color shading



FASHION BLACK

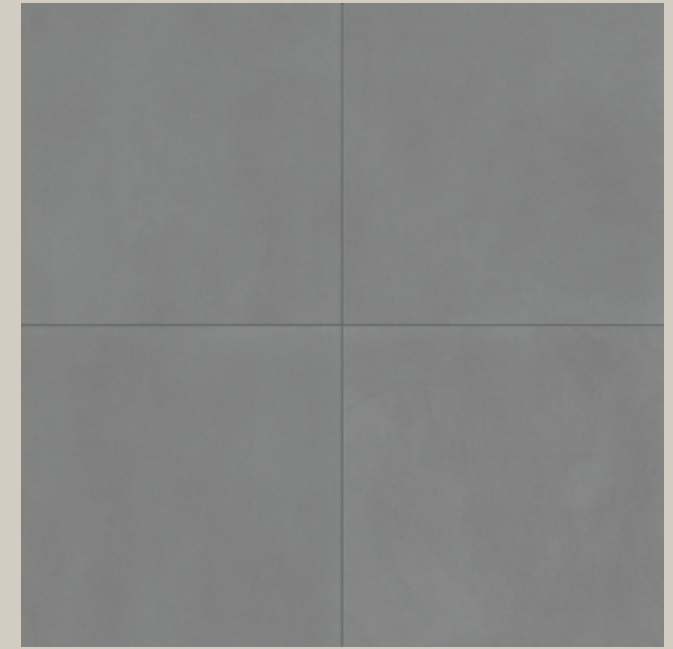

Available size

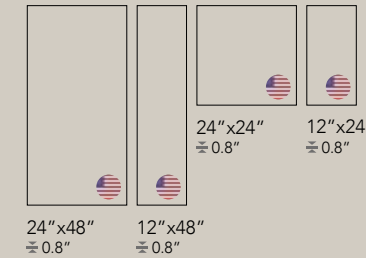

Color shading



Color Shading



The color of pavers printed in this catalog may differ from actual pavers. Paver color reproductions in this catalog are representative only. Slight tone and shade variations are inherent in porcelain pavers. Before selecting a color, we recommend that you contact your local representative, who will provide you with a sample piece of the requested paver.

This porcelain paver product is manufactured with a V2 shade variation. Remember that the amount of color as well as the texture of each piece may vary from paver to paver. Inspect the product immediately upon delivery and select pavers from many boxes during installation to minimize and blend any possible color difference.



TERRAZZO LOOK

DIAMOND WHITE



FASHION GREY

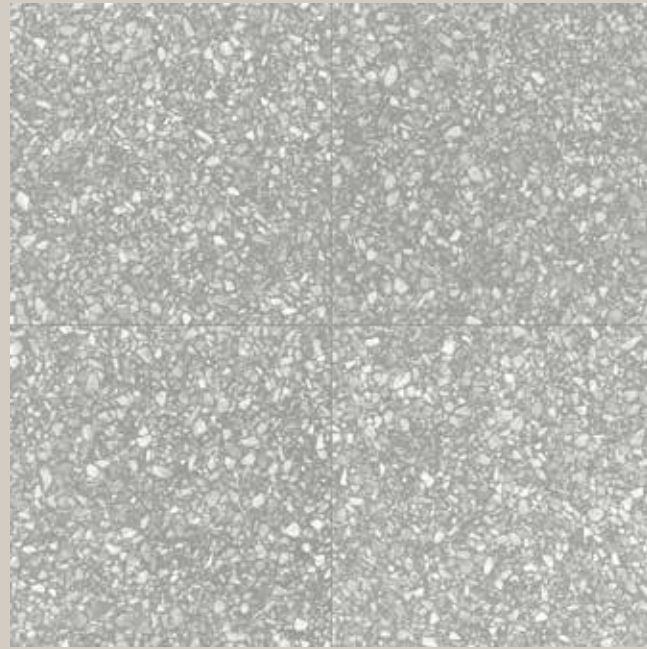

Available size



24"x24"
± 0.8"

Color shading



V2

Available size



24"x24"
± 0.8"

Color shading



V2

The color of pavers printed in this catalog may differ from actual pavers. Paver color reproductions in this catalog are representative only. Slight tone and shade variations are inherent in porcelain pavers. Before selecting a color, we recommend that you contact your local representative, who will provide you with a sample piece of the requested paver.

This porcelain paver product is manufactured with a V2 shade variation. Remember that the amount of color as well as the texture of each piece may vary from paver to paver. Inspect the product immediately upon delivery and select pavers from many boxes during installation to minimize and blend any possible color difference.

Color Shading



V1

UNIFORM APPEARANCE



V2

SLIGHT VARIATION



V3

MODERATE VARIATION



V4

SUBSTANTIAL VARIATION



PROJECT

OUTDOOR FLOOR DESIGN

Frontier20 Diamond White - 24"x24"

Frontier20 Fashion Grey - 24"x24"

Frontier20 Diamond White / Fashion Grey Stair Tread Rectified - 12"x24"

OUTDOOR WALL DESIGN

Veneer World Urban LedgeStone White Mix - 6"x24"

Elite Fashion Grey - 24"x24"



STONE LOOK

PATCHWORK WHITE



Available size

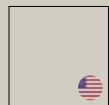

24"x24"
±0.8"

Matches with

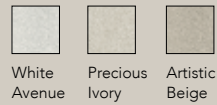

Color shading



The color of pavers printed in this catalog may differ from actual pavers. Paver color reproductions in this catalog are representative only. Slight tone and shade variations are inherent in porcelain pavers. Before selecting a color, we recommend that you contact your local representative, who will provide you with a sample piece of the requested paver.

This porcelain paver product is manufactured with a V2 shade variation. Remember that the amount of color as well as the texture of each piece may vary from paver to paver. Inspect the product immediately upon delivery and select pavers from many boxes during installation to minimize and blend any possible color difference.



STONE LOOK

PATCHWORK ASH



Available size



24"x24"
±0.8"

Matches with



Color shading



Color Shading



FRONTIER20 - DECO

COLORED BODY PORCELAIN PAVERS - Rectified Monocaliber



STONE LOOK

PATCHWORK MIX



Available size



24"x24"
± 0.8"

Matches with

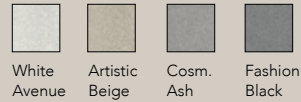

Color shading



The color of pavers printed in this catalog may differ from actual pavers. Paver color reproductions in this catalog are representative only. Slight tone and shade variations are inherent in porcelain pavers. Before selecting a color, we recommend that you contact your local representative, who will provide you with a sample piece of the requested paver.

This porcelain paver product is manufactured with a V2 shade variation. Remember that the amount of color as well as the texture of each piece may vary from paver to paver. Inspect the product immediately upon delivery and select pavers from many boxes during installation to minimize and blend any possible color difference.

Color Shading



PROJECT

OUTDOOR FLOOR DESIGN
 Frontier20 Patchwork Mix - 24"x24"
 WALL DESIGN
 Masterplan Precious Ivory - 24"x48'



QUARTZITE DESIGN PROJECT

ARCTIC WHITE



AFRICAN BEIGE



Available sizes

Color shading

Available sizes

Color shading

STAR GREY



Available sizes

Color shading



QUARTZITE DESIGN PROJECT

The color of pavers printed in this catalog may differ from actual pavers. Paver color reproductions in this catalog are representative only. Slight tone and shade variations are inherent in porcelain pavers. Before selecting a color, we recommend that you contact your local representative, who will provide you with a sample piece of the requested paver.

This porcelain paver product is manufactured with a V2 shade variation. Remember that the amount of color as well as the texture of each piece may vary from paver to paver. Inspect the product immediately upon delivery and select pavers from many boxes during installation to minimize and blend any possible color difference.

Color Shading

V1 UNIFORM APPEARANCE	V2 SLIGHT VARIATION	V3 MODERATE VARIATION	V4 SUBSTANTIAL VARIATION

◆ NOTE: 24"x36" is sold as mix (24"x36" + 12"x24") along with 12"x24". The two sizes are palletized on the same pallet and sold together.



QUARTZ LOOK

BARGE GOLD



Available sizes



24"x24"
±0.8" 12"x24"
±0.8"

Color shading



SILVER QUARTZ



Available sizes



24"x24"
±0.8" 12"x24"
±0.8"

Color shading



STONE LOOK

NATURAL IVORY

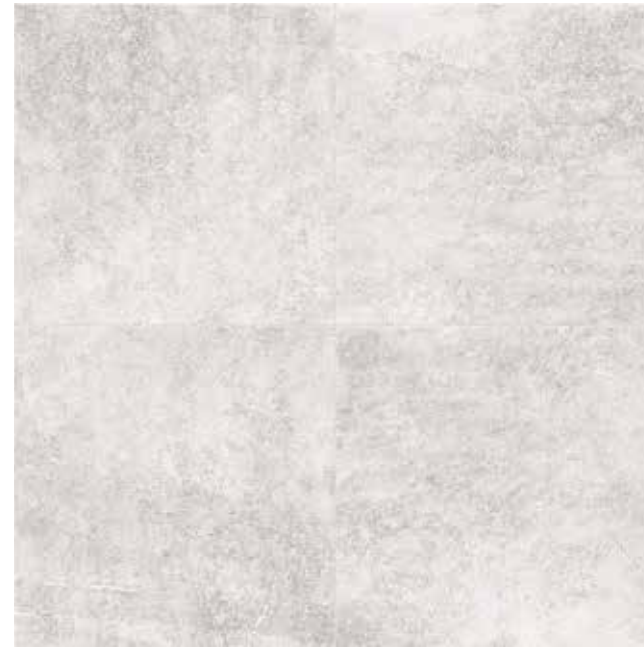

Available size



24"x24"
±0.8"

Color shading



MODERN GREY



Available size



24"x24"
±0.8"

Color shading



The color of pavers printed in this catalog may differ from actual pavers. Paver color reproductions in this catalog are representative only. Slight tone and shade variations are inherent in porcelain pavers. Before selecting a color, we recommend that you contact your local representative, who will provide you with a sample piece of the requested paver.

This porcelain paver product is manufactured with a V2/V3 shade variation. Remember that the amount of color as well as the texture of each piece may vary from paver to paver. Inspect the product immediately upon delivery and select pavers from many boxes during installation to minimize and blend any possible color difference.

Color Shading





CONCRETE LOOK

FREEDOM WHITE

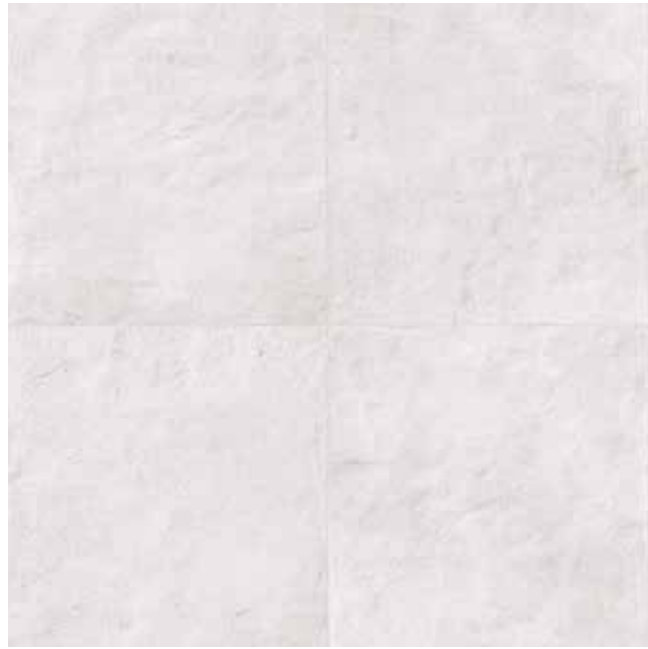

Available size



24" x 24"
± 0.8"

Color shading



PASSION SILVER



Available size



24" x 24"
± 0.8"

Color shading



SIMPLY GREY



Available sizes



24" x 24"
± 0.8"

Color shading



CONCRETE LOOK

The color of pavers printed in this catalog may differ from actual pavers. Paver color reproductions in this catalog are representative only. Slight tone and shade variations are inherent in porcelain pavers. Before selecting a color, we recommend that you contact your local representative, who will provide you with a sample piece of the requested paver.

This porcelain paver product is manufactured with a V1/V2 shade variation. Remember that the amount of color as well as the texture of each piece may vary from paver to paver. Inspect the product immediately upon delivery and select pavers from many boxes during installation to minimize and blend any possible color difference.

Color Shading



V1
UNIFORM APPEARANCE



V2
SLIGHT VARIATION



V3
MODERATE VARIATION



V4
SUBSTANTIAL VARIATION



MARBLE LOOK

MICHELANGELO EXTRA WHITE



Available sizes

24"x48" ±0.8"	12"x48" ±0.8"	24"x36" ±0.8"	24"x24" ±0.8"	12"x24" ±0.8"	12"x12" ±0.8"
------------------	------------------	------------------	------------------	------------------	------------------

Color shading

V2

◆ NOTE: 24"x36" is sold as mix (24"x36" + 12"x24") along with 12"x24".
The two sizes are palletized on the same pallet and sold together.

The color of pavers printed in this catalog may differ from actual pavers. Paver color reproductions in this catalog are representative only. Slight tone and shade variations are inherent in porcelain pavers. Before selecting a color, we recommend that you contact your local representative, who will provide you with a sample piece of the requested paver.

This porcelain paver product is manufactured with a V2 shade variation. Remember that the amount of color as well as the texture of each piece may vary from paver to paver. Inspect the product immediately upon delivery and select pavers from many boxes during installation to minimize and blend any possible color difference.

LIMESTONE LOOK

INTERNATIONAL WHITE



Available size

24"x24" ±0.8"

Color shading

V2

MINIMALIST GREIGE



Available size

24"x24" ±0.8"

Color shading

V2

Color Shading

V1 UNIFORM APPEARANCE	V2 SLIGHT VARIATION	V3 MODERATE VARIATION	V4 SUBSTANTIAL VARIATION
--------------------------	------------------------	--------------------------	-----------------------------



STONE LOOK

SKY



Available size



24" x 24"
± 0.8"

Color shading



DESERT



Available size



24" x 24"
± 0.8"

Color shading



ABSOLUTE



Available size



24" x 24"
± 0.8"

Color shading



COSMOS



Available size



24" x 24"
± 0.8"

Color shading



The color of pavers printed in this catalog may differ from actual pavers. Paver color reproductions in this catalog are representative only. Slight tone and shade variations are inherent in porcelain pavers. Before selecting a color, we recommend that you contact your local representative, who will provide you with a sample piece of the requested paver.

This porcelain paver product is manufactured with a V2 shade variation. Remember that the amount of color as well as the texture of each piece may vary from paver to paver. Inspect the product immediately upon delivery and select pavers from many boxes during installation to minimize and blend any possible color difference.



STONE LOOK

Color Shading



COLORED BODY PORCELAIN PAVERS - Rectified Monocaliber

WOOD LOOK

SOUL WALNUT



Available size



12" x 48"
± 0.8"

Color shading



V2

SOUL GREY



Available size



12" x 48"
± 0.8"

Color shading



V2

The color of pavers printed in this catalog may differ from actual pavers. Paver color reproductions in this catalog are representative only. Slight tone and shade variations are inherent in porcelain pavers. Before selecting a color, we recommend that you contact your local representative, who will provide you with a sample piece of the requested paver.

This porcelain paver product is manufactured with a V2 shade variation. Remember that the amount of color as well as the texture of each piece may vary from paver to paver. Inspect the product immediately upon delivery and select pavers from many boxes during installation to minimize and blend any possible color difference.

WOOD LOOK

ESSENCE GREY



Available size



12" x 48"
± 0.8"

Color shading



V2

ESSENCE BROWN



Available size



12" x 48"
± 0.8"

Color shading



V2

Color Shading





WOOD LOOK

WALNUT



Available size

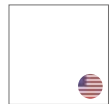

24" x 24"
± 0.8"

Color shading



V3

PEPPER



Available size

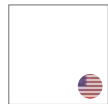

24" x 24"
± 0.8"

Color shading



V3

The color of pavers printed in this catalog may differ from actual pavers. Paver color reproductions in this catalog are representative only. Slight tone and shade variations are inherent in porcelain pavers. Before selecting a color, we recommend that you contact your local representative, who will provide you with a sample piece of the requested paver.

This porcelain paver product is manufactured with a V3 shade variation. Remember that the amount of color as well as the texture of each piece may vary from paver to paver. Inspect the product immediately upon delivery and select pavers from many boxes during installation to minimize and blend any possible color difference.

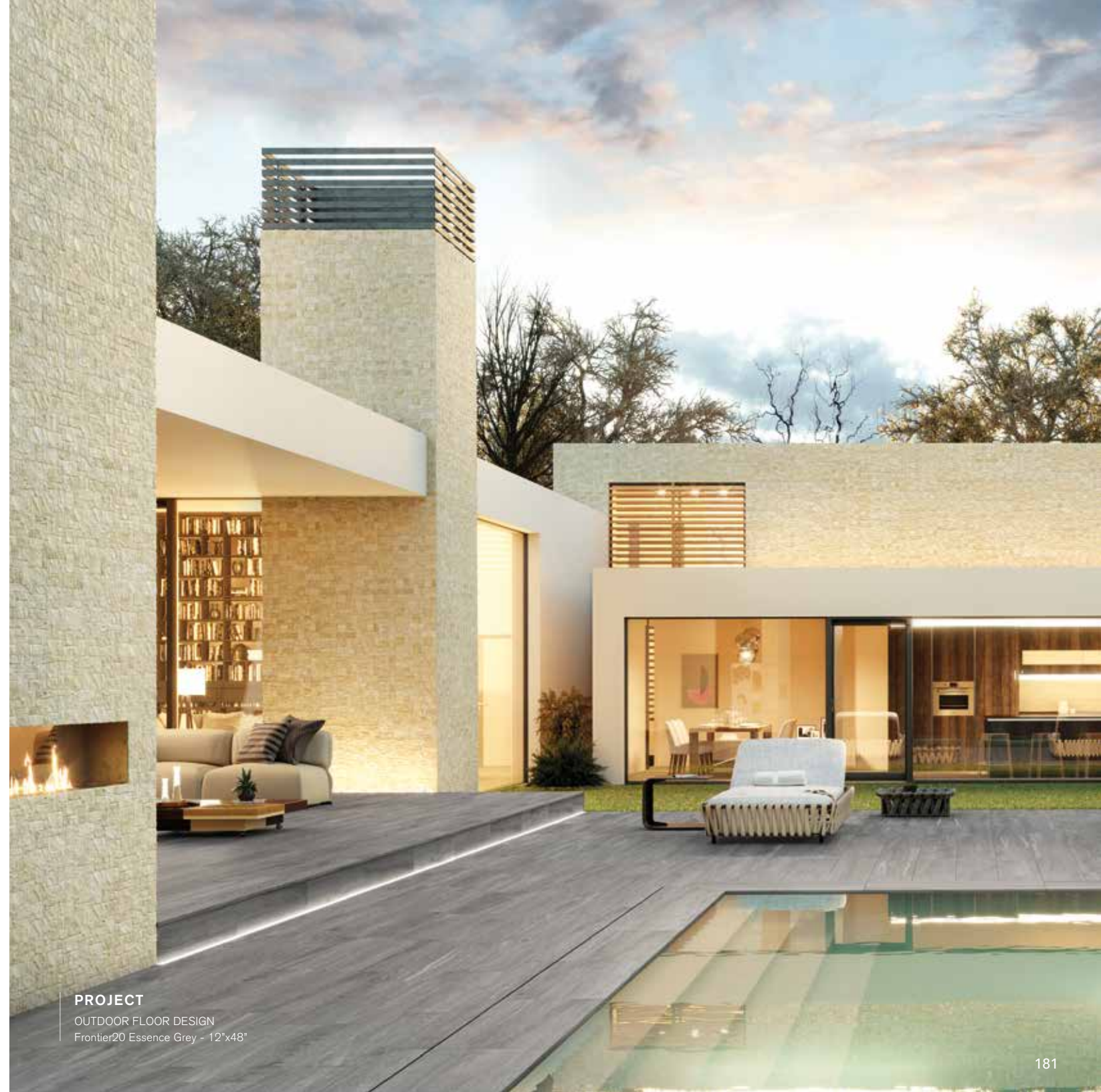

PROJECT

OUTDOOR FLOOR DESIGN
Frontier20 Essence Grey - 12"x48"

INSTALLATION INFORMATION AND RECOMMENDATIONS.

ADDITIONAL RECOMMENDATIONS FOR THE INSTALLATION, ORDINARY CLEANING AND MAINTENANCE.

Landmark Ceramics recommends carrying out the procedures for the ordinary cleaning of Frontier20 floor surfaces using water and commercially available neutral detergents: the inclination of the surface and the space between adjacent slabs for dry-system installation favor the natural flow of water. However, it is important to take into consideration that any type of floor surface is subject to the surface tension effect of liquids: it is the same property of water that gives the tendency to transform into spherical droplets and which cause the curved top surface of a glass full of water. The surface tension can obstacle the complete drainage of water and cause a temporary stagnation of liquid on the slab edges. In order to avoid this problem, Landmark Ceramics recommends ensuring adequate inclination of the surface during installation so as to encourage the flow of water between adjacent slabs. Please remember in any case that, in view of the distinctive advantages of porcelain stoneware, Frontier20 absorbs practically no water, which makes it highly frost-proof. This may lead to localized water pooling, mainly on the edges of the pavers, independently of the manner and quality of the laying. Laying is also recommended with a minimum gap of 4 mm (5/32"). Should liquid deposit on the surface, it is recommended to push it towards grout lines using a brush or remove it with a wet and dry vacuum cleaner.

Specific details and instructions are given for each of the following installation options. Different climates and geographical locations will affect the thickness of the base. Depending on the location, contractors will lay the standard base thickness to install porcelain pavers for the needs of the area. When installing porcelain pavers, the bedding course sand must be pre-compacted and then struck off with a screed to the required thickness as shown in the drawings. Before the laying of the porcelain pavers, the sand layer underneath must be pre-compacted. The sand layer needs a 5 to 6% moisture content to insure a smooth strike off finish. **Compacting dry sand will not give the desired results.**

- Only use a paver saw with a wet cut porcelain blade to wet cut porcelain pavers.
- Before installing your porcelain pavers in sand set installations, pre-compact and strike off your sand leveling course.
- Plastic 3/16" (4 mm) spacers must always be used to install pavers on sand set and permeable installations.
- Never install pavers with porcelain to porcelain contact.
- The use of plate compactors is not recommended to be used on the porcelain pavers.

PORCELAIN PAVERS JOINT FILLING.

When installing porcelain paver on sand set base, fill the 4 mm (approx. 3/16") paver joints with these options:

Traditional sand

Fill the open joints with traditional dry sand until completely filled. Sweep any excess sand off the pavers. Refilling of the joints with sand may be needed in the future due to wind and rain erosion.

Polymeric sand

Polymeric sand is a blend of polymers which harden when subjected to moisture. Sweep the sand into the open joints until completely filled. All excess sand and dust must be swept from the surface. Use a blower for the final dust removal to make certain all excess sand is removed. Any residual sand or dust can result in staining of the surface. Once the filling of the joints and the cleaning of the surface is complete, mist the pavement with water which activates the polymer and cures the mixture.

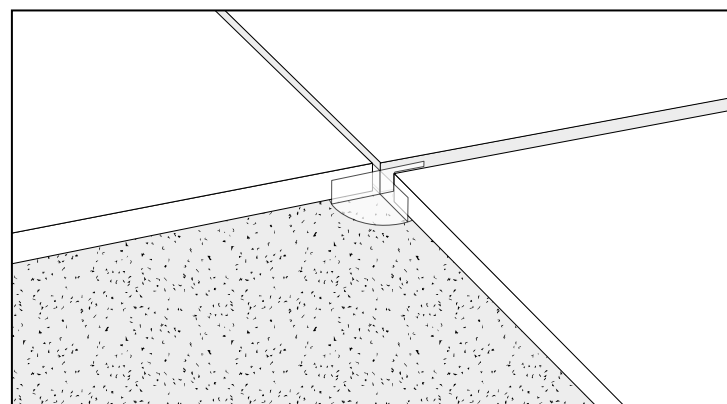

HANDLING AND SPECIALTY TOOLS.

Porcelain paver pallets are shipped with a very strong plastic covering and the individual units are packaged in protective cardboard boxes. The protective cardboard boxes guard them from the possibility of chipping. The handling of multiple loose stones can result in damaging or chipping of the pavers. Protect any un-used boxed pavers from the elements once the plastic shipping cover is removed. This insures the integrity of the protective cardboard boxes. Wet cut paver saw is used to cut paver accurately and cleanly to fit around edges and corners.

The saw must be equipped with a diamond blade manufactured for wet cutting porcelain and designed to safely cut a 24" (60 cm) length porcelain paver. A paver clamp is used to easily handle the installation and removal of pavers. Gloves are highly recommended while handling and installing porcelain slabs to protect the hands from injury. Notched trowels and grout float tools for cementitious adhesive and grout installation. Follow the adhesive and grout manufacturer's recommendations to select the appropriate tools needed for application.

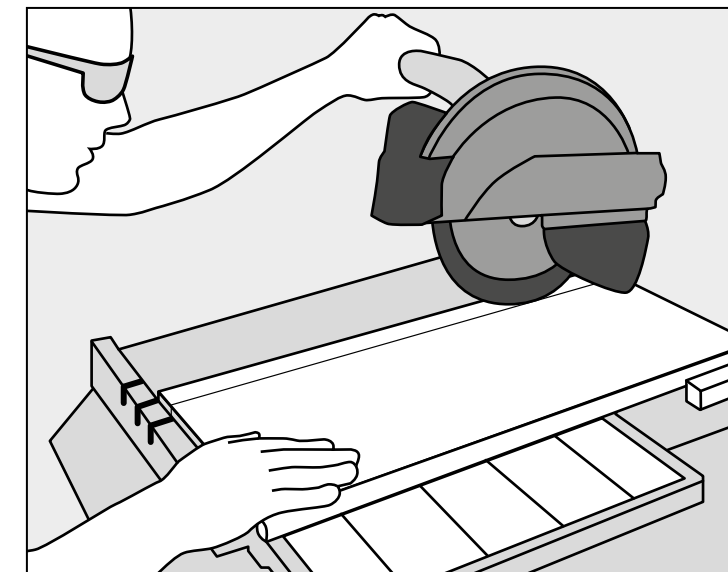
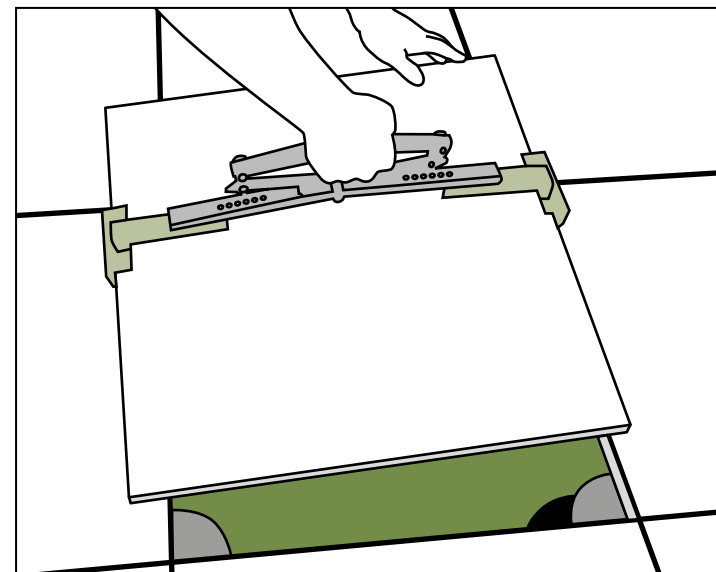

IMPORTANT NOTE: LEGAL DISCLAIMER
The nominal measurements include 4 mm (approx 3/16") for product spacers which are sold separately. Although extreme care has been taken to ensure the accuracy of all measurements set forth herein, manufacturer assumes no liability relating thereto.

IMPORTANT NOTES:
1. Use the manufacturer's instructions when choosing polymeric sand for your project.
2. The use of cement blended sand and polymeric sand can reduce plant growth and insect infiltration within the joint infill material.
3. Whether using traditional sand or a cemented blended sand, ensure the gradation of the sand is fine enough to pass through and fill the joints.

PORCELAIN PAVERS CUTTING GUIDE

LINEAR CUT.

The videos linked below show how to properly cut thick porcelain pavers (porcelain tiles with 20 mm thickness) currently used for outdoor installations. Cutting these porcelain thick pavers is very different than cutting standard thickness tiles. The extreme hardness of the material, combined with its thickness, are the main factors that will put cutting tools to the test. Based on the experience of many professional tile installers, what often happens is that the basic blades make one or two good cuts on very thick tiles and then lose their cutting power. This causes the diamond blade to be so ruined that it can't even be recovered with common abrasive stones. Many tile and brick installers have found a first solution for this: using segmented blades to cut these thicker tiles. These are more aggressive blades that easily cut this type of ceramics leaving though a very poor cutting finish. There is then the need to spend time after each cut to finish the cut edge of the tile, especially if it is going to be laid in a position that leaves that edge visible after installation. It is important that the cut is made using a professional wet saw cutting machine and that it is made by pushing (or pulling, depending on how the cutting saw is built) the blade parallel to the plane from the beginning of the cut, applying a horizontal force (figure 1 and 2) to the trolley while avoiding to push (or pull) with excessive force. **Please note that the cut has to be performed at once with one passage. It is very important to pull down the blade without touching the tile and then pull/push the disc to cut the entire paver all at once.**

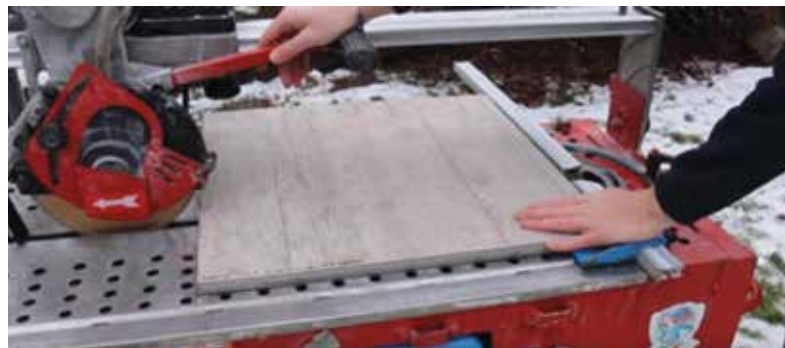

FIGURE 1



FIGURE 2

It is not recommended (figure 3) to carry out the cut by applying a force perpendicular to the side of the cutting plane (basically pushing down the saw into the tile). In fact, performing a vertical cut could affect the internal tensions of the product and lead to tile breakage.



FIGURE 3

Another cutting method consists in making a groove about 2 / 3mm deep (figure 4) by applying a very light force perpendicular to the paver surface first and then making the final cut at once with one passage, as above reported in figure 1 and 2.



FIGURE 4

In both cases, it is always recommended to use high quality disc blades and to perform the revitalization operations of the latter whenever necessary to achieve a proper cut.

Landmark Ceramics recommends using a high quality blade specific for porcelain and revive it often. By using a low quality blade, or a blade not specifically made for porcelain, it might need to be revived 2 or even 3 times during the same cut. This can lead to extra costs related to the use of many diamond abrasive stones or, even worse, it can significantly increase the likelihood of breaking the paver during the cutting process.

During cutting, Landmark Ceramics always recommends the use of abundant water before, during, and after the cutting phases to minimize the presence or dispersion of ceramic powder and to cool down the blade.

Once the cut has been completed, Landmark Ceramics recommends to clean the newly cut surface with water, in order to remove all the dust from the paver created by the cutting operation.

Please find below some links to videos of 20 mm porcelain pavers cutting:

https://www.youtube.com/watch?time_continue=2&v=rCK48yu8qV4

https://www.youtube.com/watch?time_continue=3&v=A231KShJnww

<https://www.youtube.com/watch?v=G6FVJz08ajA>

<https://www.youtube.com/watch?v=FSMntwxILRI>

PORCELAIN PAVERS CUTTING GUIDE

DRILLING HOLES WITH CORE BITS.

The creation of holes in traditional 9 / 10mm thick porcelain tile is a common practice, but it is very delicate and requires experience and technique. This is even more true for 20mm thick porcelain paver, being this particular tile thicker and more resistant. To carry out this specific cut, it is recommended to use drills or grinders together with high quality core bits for porcelain tile and paver. The use of low quality core bits could cause numerous breakages, together with an extremely accelerated wear of the tool due to the resistance of the 20mm porcelain stoneware. First of all, it is suggested to place the tile on a rigid support that absorbs the vibrations generated by the work (for example a panel of wood or regenerated rubber on a wooden panel).

After positioning the drill with the core bit in the desired position (remember to check that the drill is not in hammer mode) it is crucial to mark the exact point with a pencil, then proceed to place the core bit by tilting it slightly on the paver (**figure 5**).



FIGURE 5



FIGURE 6

Do not place the core bit perpendicularly (**figure 6**) to the paver surface as it could lead to the breakage of the paver itself.

Once the core bit is in place and already moving, gently (and without pushing too much) make a continual and constant oscillatory movement until the hole from top to bottom thorough the paver is complete (**figure 5**).

Landmark Ceramics recommendation is to use a high quality core bit specific for porcelain.

By using a low quality core bit, or a core bit not specific for porcelain, the likelihood of breaking the paver during drilling operation could increase.

During drilling, Landmark Ceramics always recommends the use of abundant water before, during, and after the drilling phase to minimize the presence or dispersion of ceramic powder and to cool down the cutter.

Once the hole has been made, Landmark Ceramics recommends to clean the hole with water, in order to remove all the dust from the surface of the paver created by the drilling.

It is also possible, whenever needed, to adjust the shape of the hole created with specific tools that soften the cut made by milling eventual sharp/irregular edges of the hole.

These tools are always made with artificial diamonds and should be specific for porcelain tiles and pavers.

Please find below a link to a video of 20 mm porcelain pavers drilling:

<https://www.youtube.com/watch?v=SVwzk894qdl>

GENERAL RECOMMENDATIONS.

Landmark Ceramics recommends using high quality tools and blades, specifically designed for porcelain. This is because 20mm thick porcelain is very strong and compact and does not behave, during cutting and drilling operations, like traditional thickness porcelain.

During cutting and/or drilling, Landmark Ceramics always recommends the use of abundant water before, during and after the drilling phases to minimize the presence or dispersion of ceramic powder and to cool the blade/core bit.

Landmark Ceramics also recommends to use certified wet or suction tools to reduce and minimize the dispersion of ceramic powder.

Once the necessary operations are finished, it is very important to clean the surface of the tile from the dust to prevent it from being trapped by the filler needed for the joints.

Landmark Ceramics always recommends the use of safety glasses, mask, gloves and steel toe shoes.

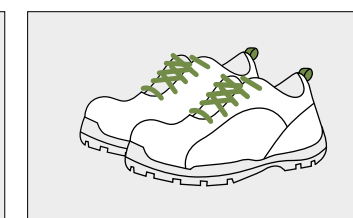
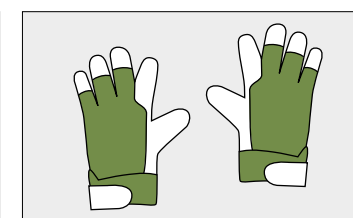
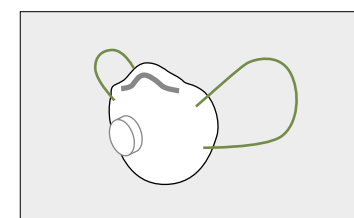
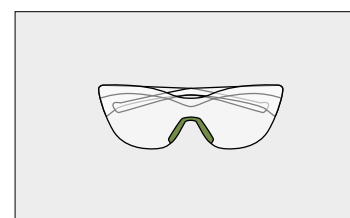

CLEANING INFORMATION FOR PORCELAIN PAVERS INSTALLED OVER CONCRETE

PORCELAIN PRODUCTS CARE AND MAINTENANCE

After any thin set installation of porcelain tile and pavers over concrete, best practices require to perform, after grouting, a first acid deep cleaning. For more information on how to perform a correct first cleaning after grouting, as well as on the right cleaning products to use, and ordinary maintenance of porcelain tiles and pavers once installed, we strongly recommend to refer to our Landmark cleaning guide. Alternatively, you can also see paragraph A, B and C here under. Failing to follow these instructions could lead to maintenance issues, most of the times derived from grout residues left on the surface of the tiles/pavers which create a film on the tiles/pavers surface itself that tends to retain dirt. If that occurs, the only way to possibly solve the issue is to perform a deep floor cleaning, using acid-based cleaners specific for porcelain and following a specific cleaning procedure described here under (See paragraph D). Please note that from time to time, depending on the type (cement-based vs epoxy), quantity and aging of the grout residue left on the tile/pavers surface, it could be really hard or even impossible to fully recover from the problem. That is why Landmark Ceramics highly suggests a first acid deep cleaning right after installing and grouting the tiles/pavers.

A) FIRST FLOOR DEEP CLEANING AFTER INSTALLATION

After Grouting the Joints (pic. 1) It is important to remove the excess grout with a sponge and clear water (pic. 2). After 12/48 hours, the grout in the joints will have "set up" / hardened significantly. There will be a noticeable residual "haze". Typically, a diluted acid cleaner specifically for removing "Grout Haze", combined with a soft scrubbing pad will remove the majority if not all the "Haze". Change your acid/water solution frequently for best results. It is also recommended to keep a bucket of clean water to remove the acid/water solution. It is recommended to keep and use clean dry towels to help remove as much residual water and keep the floor as dry as possible. Please refer to the cleaning chemical company's suggested methods and dilution rates. (pic. 3). For areas with excess grout or grout that becomes adhered to the face of the tile, further cleaning with an Acid/ Water Solution may be necessary. Please refer to the Cleaning Chemical Company's instructions as not all acids or chemicals are the same. The excess grout residue (pic. 4-5) must be removed so that it does not dry and stick on the surface. It is necessary to change the cleaning water frequently and rinse well. Care must be taken on inlayed, polished and especially Anti Slip products similar to Frontier20. The use of a floor-washing machine combined with the use of a diluted acid detergent helps reach the spaces between adjacent tiles and clean them properly. If such a cleaning procedure is not carried out, or if such cleaning is carried out too late, the grout residue creates an absorbent film, which holds dirt, making the surface difficult to clean: in this case, Landmark Ceramics will not be liable for any damage caused to the surface.



B) DAY TO DAY CLEANING

After the post-laying cleaning operation has been thoroughly carried out, as far day to day cleaning we strongly advise against the use of waxes, oily soaps, impregnating products and various treatments (water and oil repellent) on the porcelain stoneware product, as their application is unnecessary. As is often the case in certain off the shelf detergents, they contain waxes and gloss inducing additives which, after various washes, can deposit a bright coat on the floor. Sometimes, even one drop of foods such as Coca Cola, water, wine etc. ...) is sufficient to eliminate this coat, restoring the tile's original appearance, a stain effect is produced in certain zones. In these cases, the floor must be de-waxed, using products to de-wax the applied waxes, following the producer's instructions. For films left by soap, lime scale, dirt, use an acid detergent, suitably diluted in water (read the product instructions carefully). It is also important to point out that Hydrofluoric acid (HF) and its derivatives can irredeemably damage porcelain stoneware. For routine cleaning, Landmark recommends the use of bleach or ammonia, suitably diluted in water; for polished porcelain stoneware, dry the floor after washing to prevent unsightly smudges. TIP: Since rinsing well with plenty of clean water is a fundamental part of the day to day cleaning procedure, Landmark advises against the use of products which state that they "do not need rinsing"

CLEANING AGENTS

TYPE OF STAIN	SOLUTION	DETERGENTS	MANUFACTURER
INORGANIC STAINS			
Cement Carbon Calcium Efflorescence Chalk Metallic residues Rust Cement-based grout Colored grout Wall paint	Acid	DETERGENT WITH AN ACID BASIS *	
		DETERDEK or similar	UNITED STATES > Fila Chemicals USA, Corp. 10800 N.W. 21st Street #170 Miami, FL 33172 USA Tel. +1-305-513-0708 email filausa@filasolutions.com
		KERANET (liquid) or similar	MAPEI Americas Headquarters 1144 E. Newport Center Drive Deerfield Beach, Florida 33442
ORGANIC STAINS			
Coca Cola Ice Cream Coffee Wine Beer Animal fats Vegetable fats Mustard Mayonnaise Ketchup Jam Linseed oil Lipstick Wax	Alkaline and neutral	LIMITED FOAM TYPE PRODUCT **	
		PS87 or similar	UNITED STATES > Fila Chemicals USA, Corp. 10800 N.W. 21st Street #170 Miami, FL 33172 USA Tel. +1-305-513-0708 email filausa@filasolutions.com
		FILACLEANER or similar	UNITED STATES > Fila Chemicals USA, Corp. 10800 N.W. 21st Street #170 Miami, FL 33172 USA Tel. +1-305-513-0708 email filausa@filasolutions.com
		Ammonium	Universal
RESIDUAL RINGS of organic nature	Saline solution	Sodium hypochloride (bleach for white laundry)	Universal
Silicone oils Machine Oil Resins and glazes Coal and natural rubber Encres et feutres		FILASOLV or similar	UNITED STATES > Fila Chemicals USA, Corp. 10800 N.W. 21st Street #170 Miami, FL 33172 USA Tel. +1-305-513-0708 email filausa@filasolutions.com
		Aceton	Universal
		NITRO - THINNER	Universal
		TURPENTINE	Universal
		TRICHLORETHYLENE	Universal
		CIF AMMONIACAL	Universal
Tire		HAND CLEANSER	Universal
Silicone and chewin-gum		Ice+scraper	

N.B. When using the above products, the instructions on the package should be followed.

* **Detergent with an acid base:** a detergent with an acid basis, specifically recommended after bath floor or wall installation, for the decalcioficant cleaning and the regular maintenance.

** **Limited foam type product:** a limited foam type product degreasing and general cleaning, suitable for all types of stains but especially for remove of vegetable and animals fats.

CLEANING INFORMATION FOR PORCELAIN PAVERS INSTALLED OVER CONCRETE

C) EXTRAORDINARY CLEANING

In the case of particular and/or particularly stubborn stains, we recommend using specific detergents as those indicated in chart here under reported. It should furthermore not be forgotten that the removal of any type of stain is easier when the stain is still fresh. It is always important to test the detergents on a small area before applying to the entire surface, particularly in the case of porcelain stoneware with a lapped or polished finish

D) FLOOR DEEP CLEANING RECCOMANDATIONS TO BE USED IN CASE OF GROUT RESIDUES LEFT ON TILE/PAVERS SURFACE

1. Preliminary Cleaning Procedure: To begin with, it is important to clean the floor with a traditional detergent (Some examples of suitable detergents you can consider are Deterdek from Fila, Keranet from Mapei) and rinse thoroughly in order to remove any dirt that is present on the tile/pavers aside from the grout left on them. This should be done carefully by following these steps:

- I. Clean the floor with water to remove dust and residues
- II. Apply an abundant quantity of detergent (such as the one pictured below) to clean the floor, following instructions provided on the detergent's bottle and making sure that, during the entire cleaning process, the detergent does not get in contact with grass or water of nearby swimming pools (if any)
- III. Brush strongly to remove the dirt (using a scotch-brite, ideally a motor-brush with scotch brite for big surfaces)
- IV. Rinse well with running water (it is recommend to use a vacuum cleaner to avoid burning the grass)
- V. Once well rinsed, dry the surface

2. Acidic Cleaning Procedure: Perform the acid cleaning procedure as indicated in the guide provided in the link above, hereunder summarized:

- I. Apply a professional acidic cleaner for grout haze on the floor. Some examples of suitable acidic cleaners you can consider are DETERDEK from Fila, KERANET from Mapei, or professional acidic cleaners like the one pictured below:
- II. Apply an abundant quantity of acidic cleaner on the entire floor, following instructions provided on the cleaner's bottle (for a better result, do not dilute with water), and making sure that, during the entire cleaning process, the cleaner (since it is an acid-based cleaner) does not get in contact with grass or water of nearby swimming pools (if any)
- III. Once applied, leave the product on the floor for about 20-30 minutes.
- IV. Brush strongly to remove the dirt (using a scotch brite, ideally a motor-brush with scotch brite for big surfaces). It is very important to apply a strong and prolonged mechanical action (tile by tile) on the floor while brushing. Please note that cleaning without a strong mechanical action (e.g. cleaning using a simple mop) is going to be useless and ineffective.
- V. Rinse the floor, making sure everything is absorbed, so that nothing will get in contact with grass or swimming pool water
- VI. Repeat everything from point "2.i" as many times as necessary to achieve the desired result
- VII. Dry the floor's surface

E) ADDITIONAL NOTES & RECCOMANDATIONS

1. Please note that if the grouting was done well before the time of attempted cleaning, the grout residue left on the tile surface would have had time to settle and mature. In this case:

- It is particularly important, during the acid cleaning process, to let the acid settle in on the floor for a few minutes before brushing, so that the acid can soften the grout.
- It is also crucial to brush the tiles using the right tools and to apply on the floor a strong and prolonged mechanical action (tile by tile).
- It is very likely that a single deep acid cleaning will not be sufficient. In this case, it will be necessary to repeat the operation several times in order to eliminate all the grout residues. Keep in mind that the grout residue might not be immediately visible when the floor is clean, but can only be seen when the grout gets dirty. Therefore, even if the floor may appear clean after the first deep cleaning process, it could still have grout residue left on the surface of tile/pavers, that will get visible once they'll get dirty again. If that is the case, it will be necessary to repeat the deep cleaning procedure more than once until reaching a satisfactory result.

2. While performing the deep cleaning process, please be aware of any surrounding grass (making sure that the acid cleaner does not get in contact with it).

3. In case a deep cleaning is needed around a pool, make sure that during the entire cleaning process the acid cleaner does not get in contact with the water of the swimming pool.

4. Never use sealers of any kind on the surface of the porcelain tiles and pavers. Sealers are unnecessary and, furthermore, sealing will change the D.C.O.F. (Dynamic Co-efficient of Friction) of the pavers, resulting in a surface that will become more slippery. Furthermore, since Porcelain has such a low absorption rate, the sealer will unlikely stick and will most likely come off over time.

5. Bright colored products, in particular white and extra-white tiles, are very delicate and, although for all intent and purpose are hygienically clean, However, they can get dirty more easily than darker tiles. It is therefore necessary to remember that these particular products require careful regular maintenance.

WARNINGS

The above suggestions are a result of research, laboratory tests and several years' experience. However, the cleaning features of the materials may vary significantly according to the different installation methods, conditions of use, types of surface and destination. As a general rule, the higher the anti-slip values of the tiles are, the greater cleaning inconveniences may arise. The professional operator in charge of maintenance and cleaning shall always check the surface condition before proceeding with any cleaning and/or maintenance operation (we would suggest to test some tiles before installation). Landmark Ceramics declines any liability with reference to cleaning and maintenance operations in case of heavy conditions of use (such as mechanical workshop or spaces presenting oily residues or tire marks), bad installation work or wrong cleaning operations. It is agreed that Landmark Ceramics shall not be liable for any event, damage or defect due to wrong installation of the tiles, faulty cleaning and maintenance operations or inadequate choice of the type of material to be laid or of the adhesives used in a certain destination of use.

PORCELAIN PAVERS: ADDITIONAL RECOMMENDATIONS FOR THE INSTALLATION, ORDINARY CLEANING AND MAINTENANCE.

Landmark Ceramics recommends carrying out the procedures for the ordinary cleaning of Frontier20 floor surfaces using water and commercially available neutral detergents: the inclination of the surface and the space between adjacent slabs for dry-system installation favor the natural flow of water. However, it is important to take into consideration that any type of floor surface is subject to the surface tension effect of liquids: it is the same property of water that gives the tendency to transform into spherical droplets and which cause the curved top surface of a glass full of water. The surface tension can obstacle the complete drainage of water and cause a temporary stagnation of liquid on the slab edges. In order to avoid this problem, Landmark Ceramics recommends ensuring adequate inclination of the surface during installation so as to encourage the flow of water between adjacent slabs. Please remember in any case that, in view of the distinctive advantages of porcelain stoneware, Frontier20 absorbs practically no water, which makes it highly frost-proof. This may lead to localized water pooling, mainly on the edges of the pavers, independently of the manner and quality of the laying. Laying is also recommended with a minimum gap of 4 mm (5/32"). Should liquid deposit on the surface, it is recommended to push it towards grout lines using a brush or remove it with a wet and dry vacuum cleaner.

PERFORMANCE COMPARISON PORCELAIN PAVERS VS. COMPETITOR OUTDOOR PAVING MATERIALS

FEATURES	LANDMARK FRONTIER20 PORCELAIN PAVERS	WOOD PAVERS	CLAY BRICK	CIP (CAST IN PLACE) CONCRETE	CONCRETE PAVERS	NATURAL STONE
Stainable	No	Yes	Yes (Highly)	Yes	Yes	Yes (Highly)
Freeze Thaw Proof	Yes	No	No	No	No	No
Salt Resistant	Yes	No	Salt Will Degrade	No	No	No
Acid Resistant	Yes	No	Acid Will Burn	No	No	No
Scratch Resistant	Highly	No	Somewhat	No	No	No
Moisture Absorption	< 0,5%	Highly Varried	5%	5%	5-10%	≥ 5%
Easy To Repair	Yes	Yes	No	Can Not	No	No
Uv Resistant	Unaffected	No	Yes	If Sealed	Yes/No	Unaffected
Needs Sealed	Never	Yes	Recommended	Recommended	Recommended	Recommended
Pressure Washer Safe	> 1500 PSI	No	Not Recommended	> 1500 PSI	No	No
Environmentally Friendly	Facility 98% Green	Many Exotic Rainforest Species	No	Large Carbon Foot Print	Possible Fly Ash Content	Mined Or Imported
Recycled Content	5% In Each Paver	No	Not Possible	Not Possible	If Possible Less Than 5%	Not Possible

PHYSICAL PROPERTIES	TEST ASTM	NORTH AMERICAN STANDARD A137.3*	RESULTS
Water absorption *	C373	≤ 0.5%	COMPLY WITH ANSI A137.3
DCOF Average dynamic coefficient of friction **	ANSI A.326.3	As reported	EW - Exterior, Wet
Skid Resistance	EN 16165 (EX DIN 51097)	-	A+B+C
	EN 16165 (EX DIN 51130)		R11
Resistance to freeze/thaw cycling *	C1026	As reported	RESISTANT
Resistance to thermal shock	C484	As reported	RESISTANT
Warpage (edge)	C485	Warpage ± 0.4% or ± 0.05 in	COMPLY WITH ANSI A137.3
Warpage (diagonal)	C485	Warpage ± 0.4% or ± 0.07 in	COMPLY WITH ANSI A137.3
Wedging	C502	± 0.25% or ± 0.03 in	COMPLY WITH ANSI A137.3
Chemical resistance	C650	As reported	UNAFFECTED
Resistance to stain	C1378	As reported	UNAFFECTED
Thickness	C499	Range: 0.04 in	COMPLY WITH ANSI A137.3
Breaking strength	C1050	2000 lbf	COMPLY WITH ANSI A137.3
Module of Ropture	C1050	5000 psi	COMPLY WITH ANSI A137.3

* Average values referred to our production and related to the matt finish of the product.

** As far as values relating to the matt finish of the product and to tests carried out by certified external laboratories whose results are available upon request at Headoffice, we are willing to check the lot you are interested in purchasing.

- Be sure to use pavers belonging to the same caliber.

- Test results are available on request.

- The information provided can be subject to change. Please refer to one of our websites (lusa.com or outdoor.landmarkceramics.com) for the latest, most accurate and up-to-date information.

WARNINGS.

- Outdoor pavings installed unglued above the ground level are subject to the action of the wind, with the risk, in some cases, of becoming airborne. The manufacturer recommends to require the assistance of a qualified professional in order to check the suitability of the installation system above the ground adopted, in accordance with the local laws and regulations and the conditions of use. Failure to do so could result in serious injury or property damage.
- If the application of the 20 mm slabs requires the ceramic product used in structural installations, the project engineer and/or customer must carefully assess the project requirements with regard to the technical specifications of the slabs. To prevent the risk of damage or injury, the manufacturer recommends: with regard to a raised floor installation a ceramic slab may fracture on impact if a heavy object falls on it from any significant height. Therefore the manufacturer recommends to check the specific intended use before starting the installation and to follow the table for raised installation provided below. In certain conditions, reinforcing must be applied on the back of the slabs (double fiberglass mesh) supplied and applied by the manufacturer; with reference to any dry installation system of flooring above the ground level, the manufacturer recommends to comply with local regulations and conditions of use with regard to wind-load, loadbearing, seismic events, etc. Failure to comply with these recommendations may lead to improper use of the product and could cause serious damage or injury. Failure to adhere to the manufacturer's instructions for installation of slabs on raised pedestal systems may result in serious injury.
- For further information and recommendations concerning the installation systems please refer to outdoor.landmarkceramics.com website.





LANDMARK
CERAMICS

Landmark Ceramics - UST, Inc.

1427 N. Main Street
Mount Pleasant, TN 38474

Tel. 931.325.5700

outdoor.landmarkceramics.com

LEARN MORE ABOUT

